

Version: EN -UM-1.2

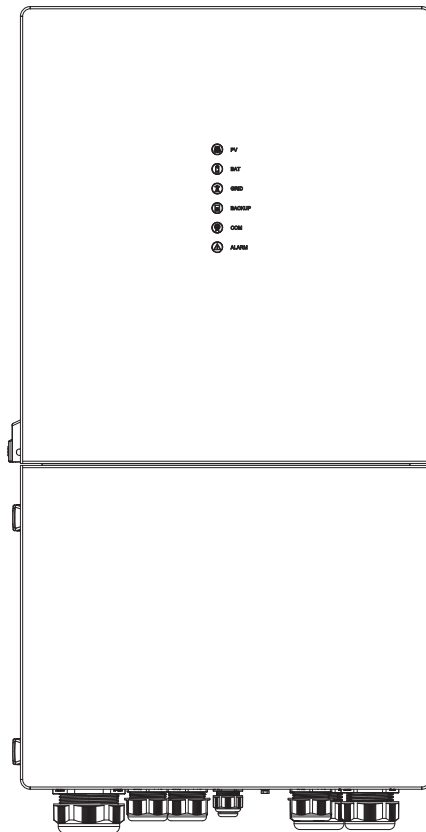

# USER MANUAL

---

## ESS Inverter

## HISTORY

VERSION	ISSUED	COMMENTS
1.0	21-Dec.-22	First release
1.1	16-May-23	Update Chapter 4 Electrical Connection. Change CT connection from Pin 5,6 to Pin 9,10.
1.2	8-June-23	Change the cover and switch time from 1 second to 5 seconds.

# Preface

## About This Manual

This manual describes the installation, connection, APP setting, commissioning and maintenance etc. of ESS inverter. Please first read the manual and related documents carefully before using the product and store it in a place where installation, operation and maintenance personnel can reach it at any time. The illustrations in this user manual are for reference only. This user manual is subject to change without prior notice. (Specific please in kind prevail.)

## Target Group

ESS inverters must be installed by professional electrical engineers who have obtained relevant qualifications.





## Scope

This manual is applicable to following inverters:

- 8K EU
- 10K EU

## Conventions

The following safety instructions and general information are used within this user manual.

 <b>DANGER</b>	Indicates an imminently hazardous situation which, if not correctly followed, will result in serious injury or death.
 <b>WARNING</b>	Indicates a potentially hazardous situation which, if not correctly followed, will result in serious injury or death.
 <b>CAUTION</b>	Indicates a potentially hazardous situation which, if not correctly followed, could result in moderate or minor injury.
 <b>NOTICE</b>	Indicates a potentially hazardous situation which, if not correctly followed, could result in equipment failure to run, or property damage.
 <b>NOTE</b>	Call attention to important information, best practices and tips: supplement additional safety instructions for your better use of the Three phase hybrid inverter to reduce the waste of you resource.

# CONTENTS

## **Preface**

About This Manual

Target Group

Scope

Conventions

## **1. Safety**

1.1 Symbols Used

1.2 Safety Precaution

## **2. Product Introduction**

2.1 Overview

2.2 Product Appearance

## **3. Installation**

3.1 Packing List

3.2 Selecting the Mounting Location

3.3 Mounting

## **4. Electrical Connection**

4.1 Grounding

4.2 Meter/CT Connection

4.3 Communication Connection

## **5. System Operation**

5.1 Inverter Working Mode

5.2 Startup/Shutdown Procedure

## **6. Commissioning**

6.1 Inspection

6.2 Commissioning Procedure

## **7. User Interface**

7.1 LED

7.2 App Setting Guide

## **8. Maintenance**

8.1 Routine Maintenance

8.2 Inverter Troubleshooting







## **9. Technical Specifications**

# 1. Safety

Before using the inverter, please read all instructions and cautionary markings on the unit and in this manual. Put this manual to a place where you can take it easily.

Our ESS inverter strictly conforms to related safety rules in design and test. Please follow the local laws and regulations during installation, operation and maintenance. Incorrect operation may cause injury or death to the operator or a third party, and damage to the inverter and other properties belonging to the operator or a third party.

## 1.1 Symbols Used

Safety Symbol	Description
	Danger of high voltage and electric shock! Only qualified personnel may perform work on the inverter.
	Residual voltage exists after the inverter is powered off. It takes 5 minutes for system to discharge to a safe voltage.
	Danger of hot surface
	Environmental Protection Use Period
	Refer to the operating instructions
	Product should not be disposed as household waste.
	Grounding terminal

## 1.2 Safety Precaution

- Installation, maintenance and connection of inverters must be performed by qualified personnel, in compliance with local electrical standards, wiring rules and requirements of local power authorities and/or companies.
- The temperature of some parts of the inverter may exceed 60°C during operation. Do not touch the inverter during operation to avoid being burnt.
- Ensure children are kept away from inverters.
- Don't open the front cover of the inverter. Apart from performing work at the wiring terminal (as instructed in this manual), touching or changing components without authorization may cause injury to people, damage to inverters and annulment of the warranty.
- Static electricity may damage electronic components. Appropriate methods must be adopted to prevent such damage to the inverter; otherwise the inverter may be damaged and the warranty annulled.
- Ensure the output voltage of the proposed PV array is lower than the maximum rated input voltage of the inverter; otherwise the inverter may be damaged and the warranty annulled.
- When exposed to sunlight, the PV array generates dangerous high DC voltage. Please operate according to our instructions, or it will result in danger to life.
- PV modules should have an IEC61730 class A rating.
- If the equipment is used in a manner not specified by the manufacturer, the protection provided by the equipment may be impaired.
- Completely isolate the inverter before maintaining. Completely isolate the inverter should: switch off the PV switch, disconnect the PV terminal, disconnect the battery terminal, and disconnect the AC terminal.
- After the inverter is powered off, the remaining electricity and heat may still cause electric shock and body burns. Do not touch parts of inverter for 10 minutes after disconnection from the power sources.
- Prohibit inserting or pulling the AC and DC terminals when the inverter is running.
- In Australia, the inverter internal switching does not maintain the neutral continuity. And neutral integrity must be addressed by external connection arrangements.
- Don't connect Three phase hybrid inverter in the following ways:  
BACKUP Port should not be connected to grid;  
The single PV panel string should not be connected to two or more inverters.

## 2. Product Introduction

### 2.1 Overview

#### ESS Inverter

The ESS inverter is a high-quality inverter which can convert solar energy to AC energy and store energy into battery. Typically, an ESS inverter system consists of PV array, ESS inverter, battery, loads and electricity sensor.

The energy generated by inverter can be preferentially supplied to its self-consumption, stored in the battery for future use or fed into public grid.

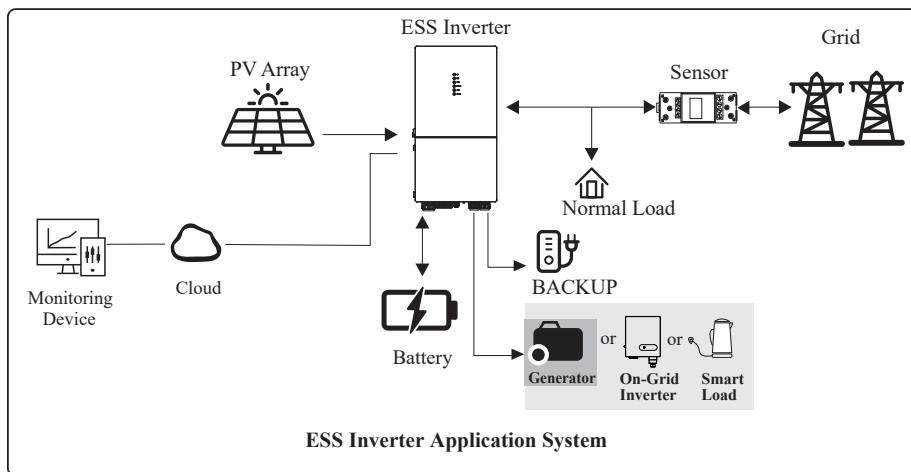



## 2.2 Product Appearance

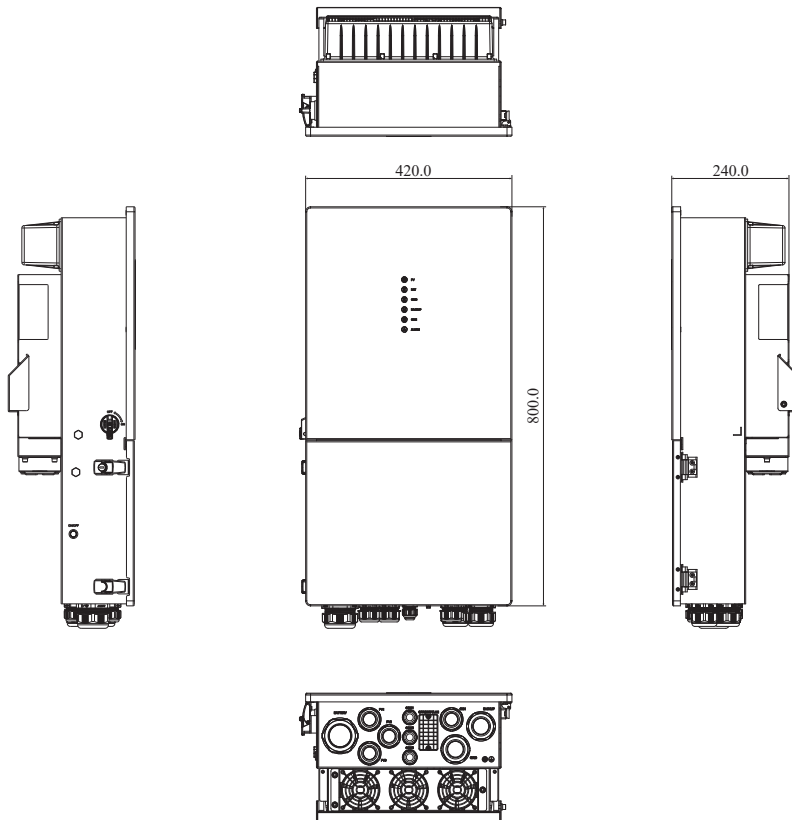

-  PV
-  BAT
-  GRID
-  BACKUP
-  COM
-  ALARM

LED Details

Width(mm)	Height(mm)	Depth(mm)
420	800	240

LED Indicators	PV	BAT	GRID	BACKUP	COM	ALARM

### The External View of ESS Inverter

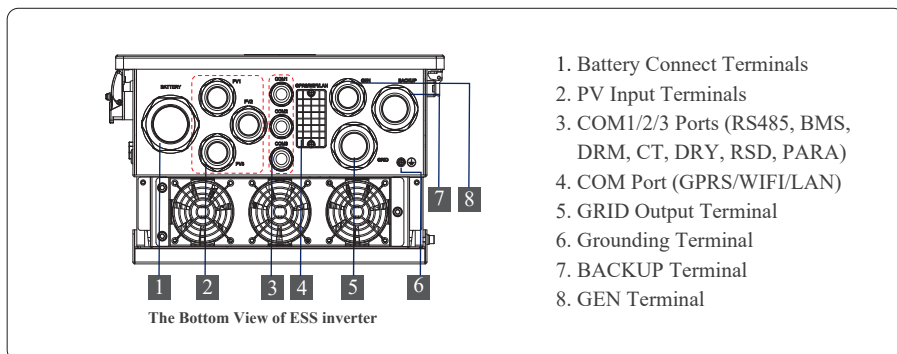
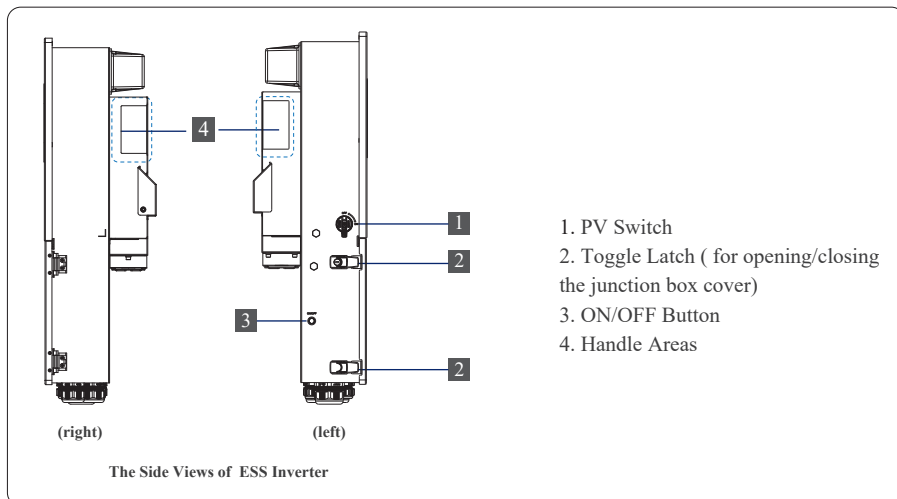

### 3. Installation

#### 3.1 Packing List

After unpacking, please check the following packing list carefully for any damage or missing parts. If any damage or missing parts occurs, contact the supplier for help.

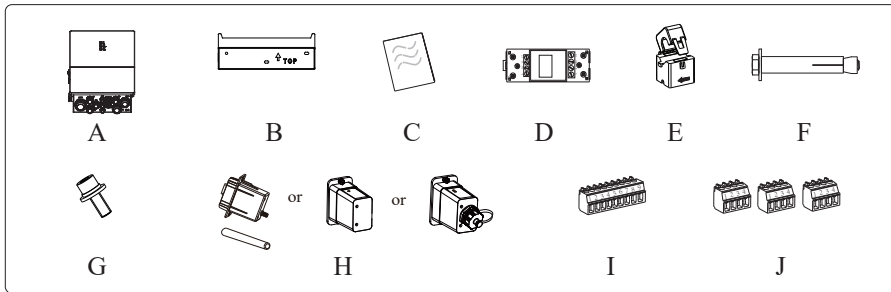

Number	Quantity	Description
A	1	Inverter
B	1	Mounting bracket
C	1	File package
D	1	Meter (Optional)
E	1	CT
F	3	M6 Expansion screws
G	1	M6 Security screw
H	1	GPRS/WIFI/LAN module (Optional)
I	1	9-Pin terminal
J	3	4-Pin terminal

### 3.2 Selecting the Mounting Location

#### 3.2.1 Installation Environment Requirements

- a. With an IP65 protection rating, the inverter can be mounted indoors or outdoors.
- b. The mounting location must be inaccessible to unrelated personnel since the enclosure and heat sinks are extremely hot during operation.
- c. Do not install the inverter in areas containing highly flammable materials or gases.
- d. To ensure optimum operation and long service life, the ambient temperature must be below 50°C.
- e. The inverter must be mounted in a well-ventilated environment to ensure good heat dissipation.
- f. To ensure long service life, the inverter must not be exposed to direct solar irradiation, rain, or snow. It is recommended that the inverter be mounted in a sheltered place.
- g. The carrier where the inverter is mounted must be fire-proof. Do not mount the inverter on flammable building materials.
- h. Do not install the inverter in a rest area since it will cause noise during operation.
- i. The installation height should be reasonable, and please make sure it is easy to operate and view the display.
- j. Product label and warning symbols shall be clear to read after installation.
- k. Please avoid direct sunlight, rain exposure, snow cover.

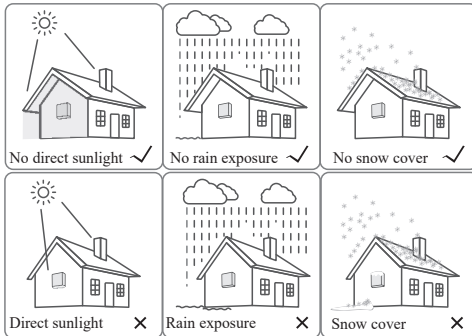

### 3.2.2 Mounting Requirements

Mount the inverter vertically or tilted backward by max 15°. The device can not be installed with a wrong mode and the connection area must point downward.

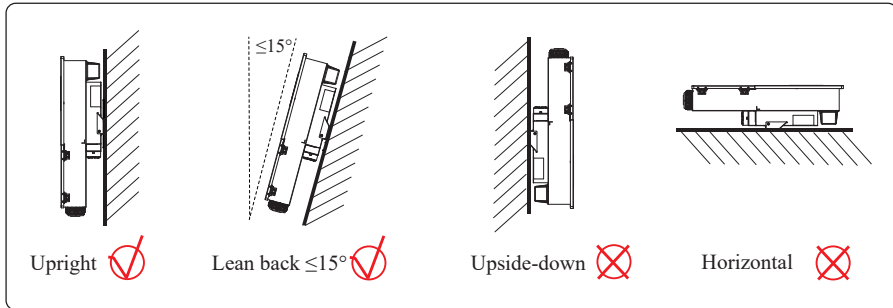

### 3.2.3 Installation Space Requirements

To ensure the inverter is normal and easy to operate, there are requirements on available spaces of the inverter, e.g. to keep enough clearance. Refer to the following figures.

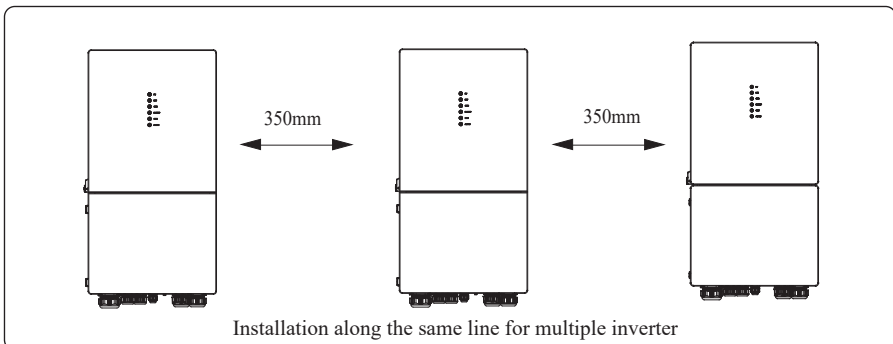
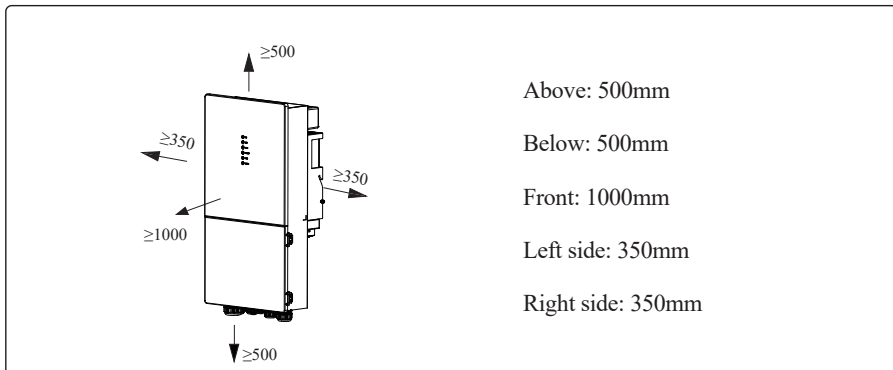

### 3.3 Mounting

Before mounting the inverter, you have to prepare expansion screws and a security screw.

#### Step 1. Install the mounting bracket

1. Use a level ruler to mark the position of the 3 holes on the wall. Refer to Figure a. And drill 3 holes, 16mm in diameter and 55mm in deep. Refer to Figure b.
2. Knock the expansion screw kit into the hole together with a hammer. Refer to Figure c.  
*Note: Do not remove the nut unit in this step.*
3. After tightening 2-3 buckles, the expansion bolts are tight and not loose, and then unscrew the bolts, spring washer, gasket. Refer to Figure c.
4. Install and fix the mounting bracket on the wall. Refer to Figure d.

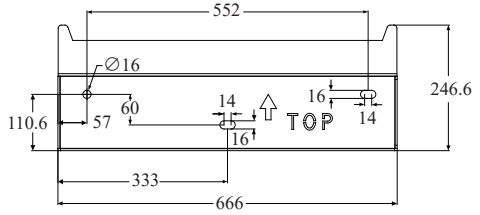

Unit: mm

#### Step 2. Install the inverter on the mounting bracket. Then lock the inverter using the security screw. Refer to Figure e, Figure f.

Note: two or three persons are recommended to install the inverter.

<p>Set bracket horizontally. Mark the holes position on the wall.</p> <p><b>a</b></p>	<p>Ø: 16mm; Depth: 55mm</p> <p><b>b</b> Drill the holes.</p>	<p>Expansion screw group (M6; 3 suites)</p> <p><b>c</b> Install the expansion tubes.</p>
<p><b>d</b></p>	<p><b>e</b> Install the inverter.</p>	<p>M6 Security screw; 2.5 N·m</p> <p><b>f</b></p>

<p><b>DANGER</b></p>	<p>Before drilling the hole on the wall, ensure no damage on the electric wire and/or water pipe inside the wall.</p>
<p><b>CAUTION</b></p>	<p>To prevent potential damages and injuries from inverter falling down, please hang the inverter on the bracket, do not loosen grip unless confirm that the inverter is well-mounted.</p>

## 4. Electrical Connection

This chapter shows the detailed connections of ESS inverter. The following illustration only uses the hybrid inverter as an example.

ESS inverter system connection diagram:

Non-parallel connection mode

Single phase (220V/230V/240Vac) connection diagram

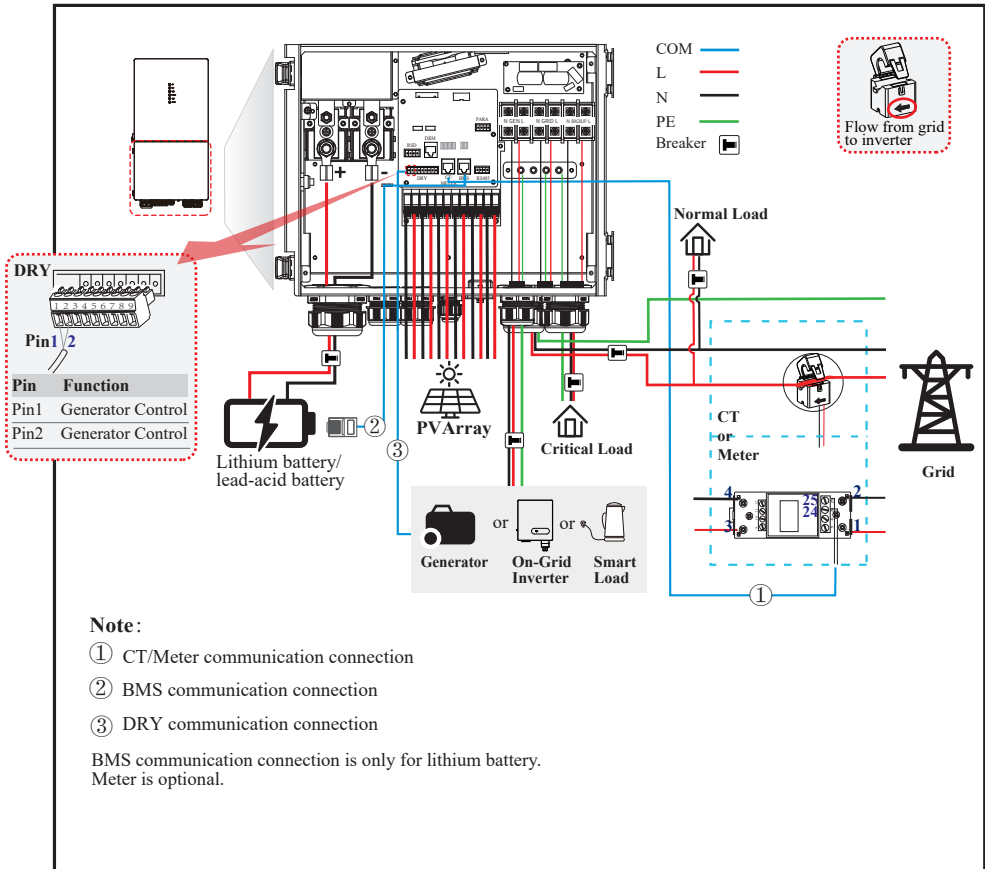

### Single phase parallel connection mode-Scheme A (N=2)

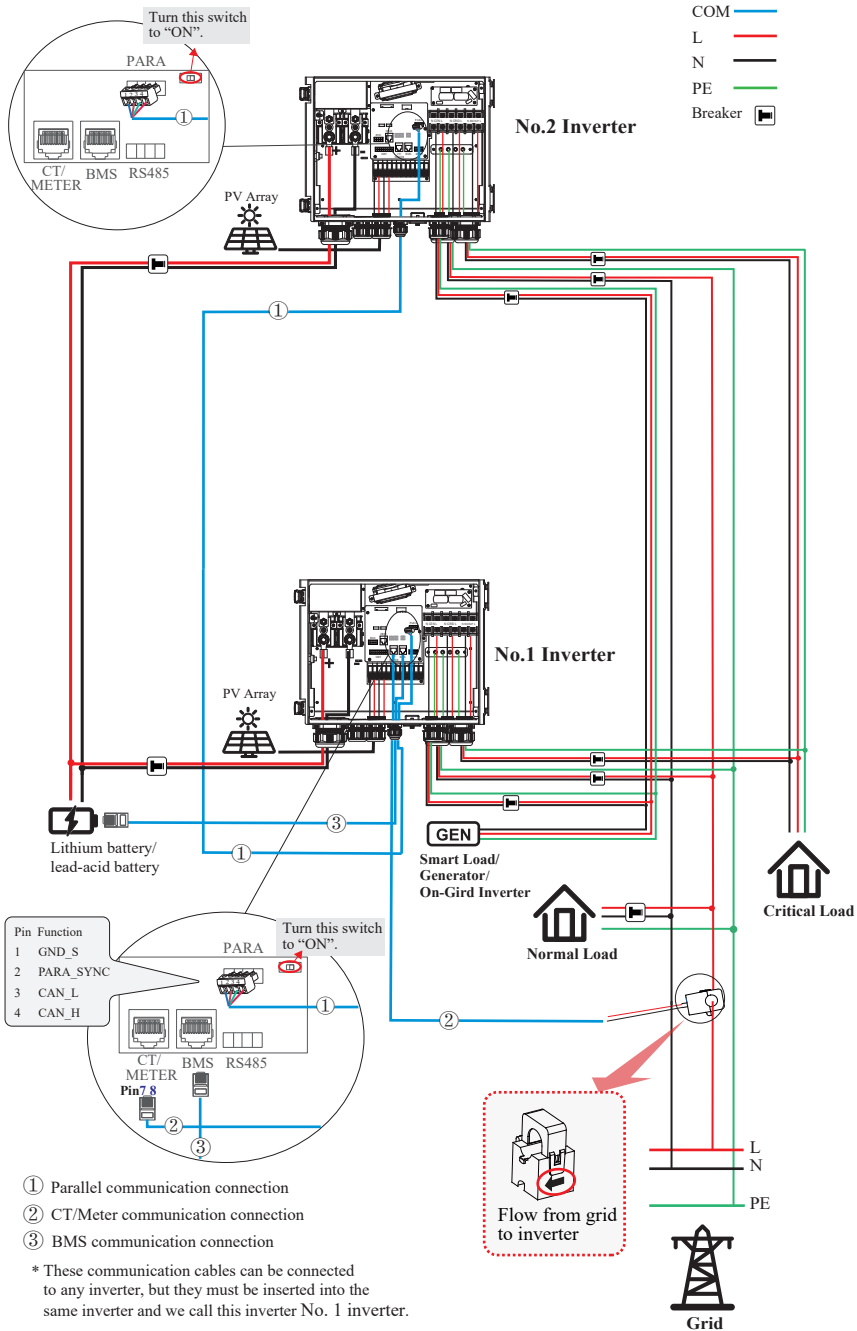



Note:

1. BMS communication connection is only for lithium battery.
2. It is necessary to turn the matched resistance switch of No. 1 inverter and No. 2 inverter to “ON” in parallel connection mode.
3. With parallel connection mode, it is necessary to connect APP to one of inverters and then go to [Console > Other Setting](#) page to enable [Parallel mode](#) on APP.

4. About breakers:

DC breaker on BATTERY side: 300A/80V

AC breaker on GEN side  $\geq$  60A/250V

AC breaker on Grid side  $\geq$  70A/250V

AC breaker on Backup side  $\geq$  70A/250V

 <b>DANGER</b>	Ensure that the inverter and all cables to be installed have been completely powered off during the whole process of installation and connection. Otherwise, fatal injury could be caused by the high voltage.
---	--

# Single phase parallel connection mode-Scheme B (N>2)

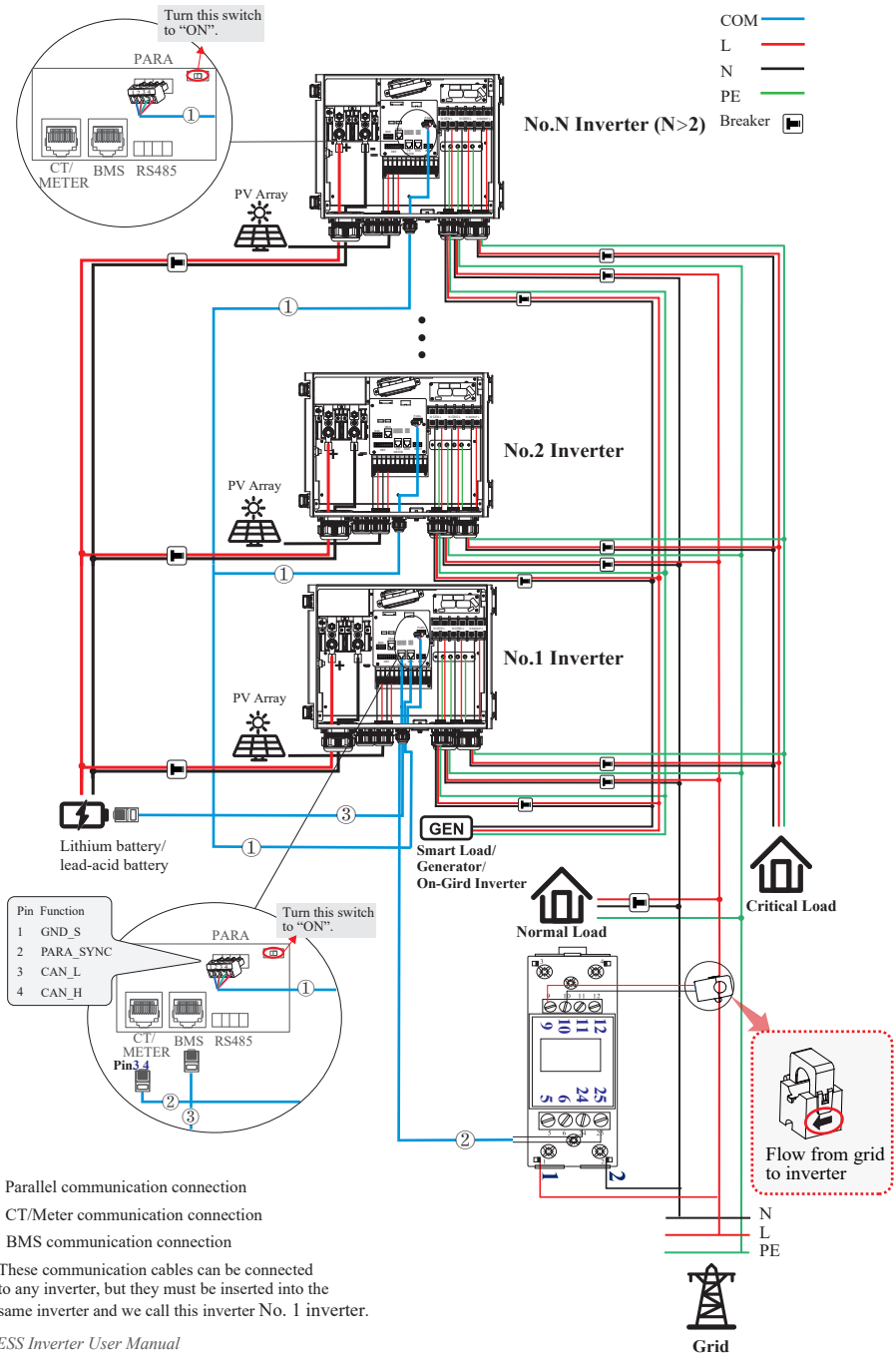

Note:

1. BMS communication connection is only for lithium battery.
2. It is necessary to additionally purchase suitable CT and meter according to the specific requirements in parallel connection mode-Scheme B.
3. It is necessary to turn the matched resistance switch of No. 1 inverter and No. N inverter to “ON” in parallel connection mode.
4. With parallel connection mode, it is necessary to connect APP to one of inverters and then go to [Console > Other Setting](#) page to enable [Parallel mode](#) on APP.
5. About breakers:

DC breaker on BATTERY side: 300A/80V

AC breaker on GEN side  $\geq 60A/250V$

AC breaker on Grid side  $\geq 70A/250V$

AC breaker on Backup side  $\geq 70A/250V$





**DANGER**

Ensure that the inverter and all cables to be installed have been completely powered off during the whole process of installation and connection. Otherwise, fatal injury could be caused by the high voltage.

## 4.1 Grounding

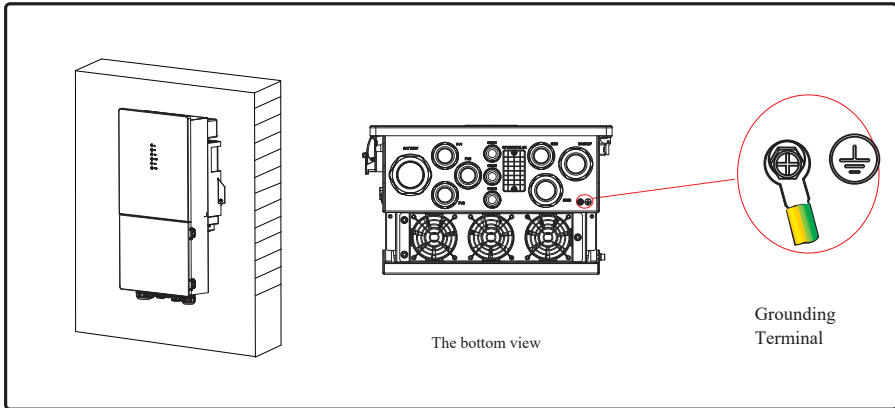
A protective earth (PE) terminal is equipped at the side of the inverter. Please be sure to connect this PE terminal to the PE bar for reliable grounding. AWG 2 or 4 yellow green lines are recommended.



 <b>WARNING</b>	The inverter must be grounded; otherwise, there may be electric shock risk.
 <b>CAUTION</b>	If the positive pole or negative pole of the PV array is required to be grounded, then the inverter output (to AC grid) must be isolated by transformers in accordance with IEC62109-1, -2 standards.

## 4.2 Meter/CT Connection

You can monitor usage with a meter or a CT.

### 4.2.1 Meter Connection

This section is applicable to non-parallel connection mode only.

ESS inverter supports the meter CHINT-DDSU666 meter by default. The meter is optional.

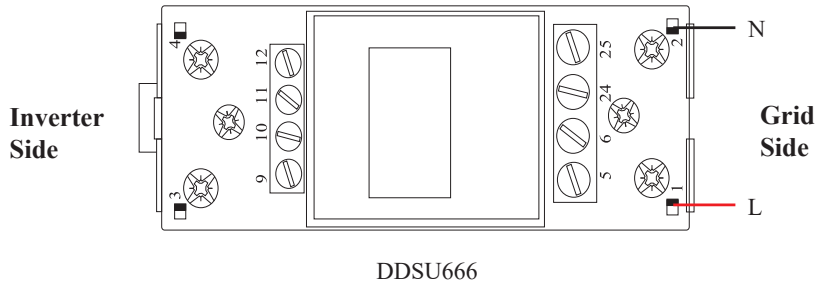

Before connecting to Grid, please install a separate AC breaker ( $\geq 70\text{A}$ ; not equipped) between meter and Grid. This ensures that the inverter can be safely disconnected during maintenance.

The connection diagram of power cable of meter is shown in the figure below:

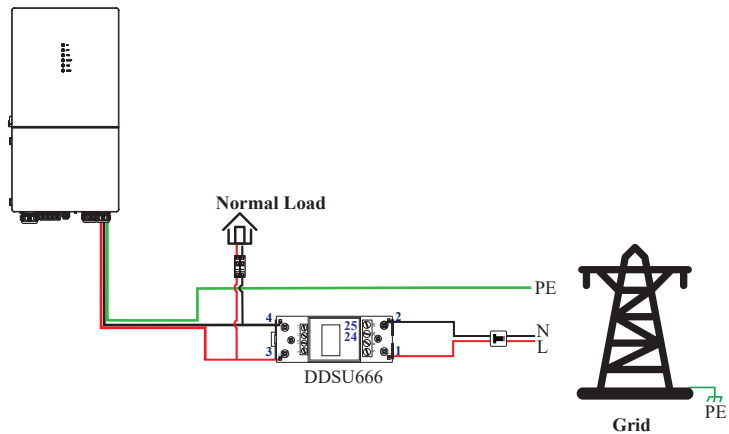

Please refer to the meter instruction manual for details.

#### 4.2.2 CT Connection

Before connecting to Grid, please install a separate AC breaker ( $\geq 70\text{A}$ ; not equipped) between CT and Grid. This will ensure the inverter can be safely disconnected during maintenance.

The connection diagram of power cable of CT is shown in the figure below:

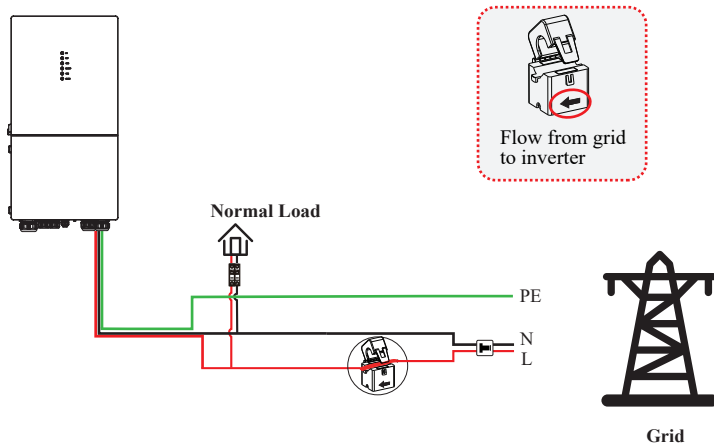

Please attention to the Current interchanger (CT) connection. The arrow on the CT indicates the current flow from grid to inverter. And lead the live line through the detection hole of CT.

 <b>NOTE</b>	The current direction from grid to inverter is defined as positive and current direction from inverter to grid is defined as negative.
---	--

### 4.3 Communication Connection

There are communication interfaces in the communication port on the bottom of the inverter as shown below:

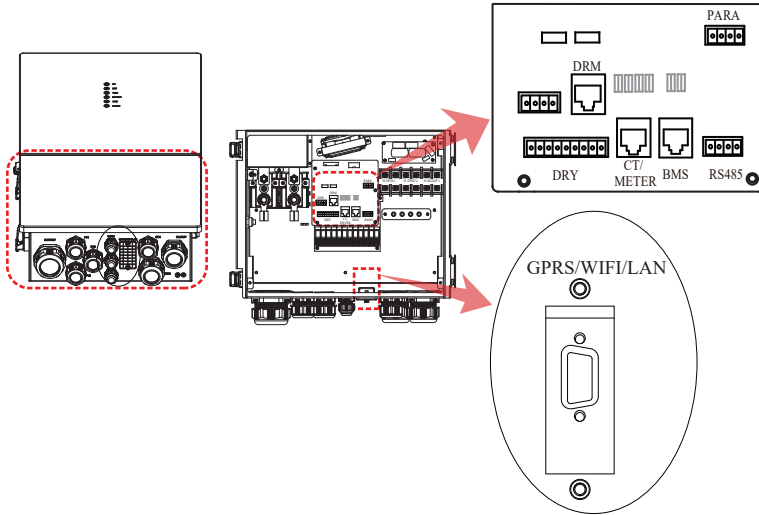

Interface		Descriptions
PARA		4-Pin interface for parallel communication
		A matched resistance switch for parallel communication
RS485		4-Pin interface for RS485 communication
DRM		Demand response mode for Australia application
CT/METER		For CT/Meter communication or Grid current sense
BMS		Lithium battery communication interface
9-Pin	GEN	Generator control
	NTC	Temperature sensor terminal of lead-acid battery
	RMO	Remote off control
	DRY	DI/DO control
GPRS/WIFI/LAN		For GPRS/WIFI/LAN communication

### 4.3.1 BMS Connection (Only for Lithium Battery)

#### RJ45 Terminal Configuration of Battery Communication (BMS)

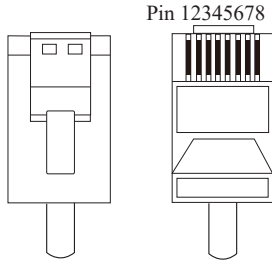

<b>PIN</b>	1	2	3	4
<b>Function Description</b>	RS485_A	RS485_B	/	CAN_H
<b>PIN</b>	5	6	7	8
<b>Function Description</b>	CAN_L	/	/	/

*This manual describes the cable sequence of the inverter. For details about the cable sequence of the battery, see the manual of the battery you used.*

#### Refer to the following step:

- a. Make the RJ45 terminal according to above function description of each Pin definition.

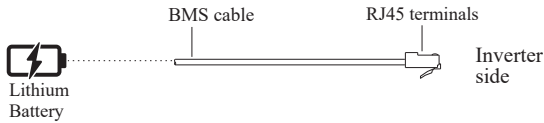

- b. Lead the BMS cable through the gland. And insert the RJ45 terminals into corresponding ports.

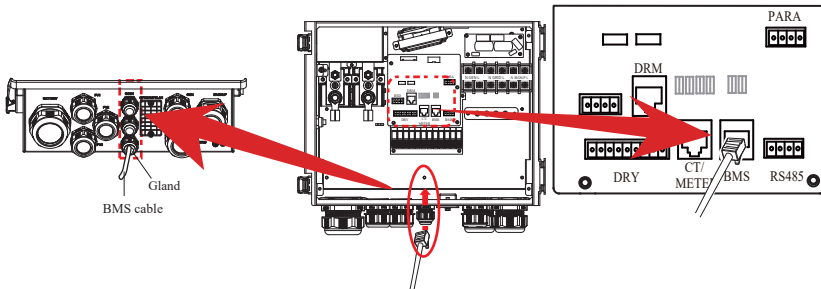



### 4.3.2 Meter Connection

#### RJ45 Terminal Configuration of Meter Communication

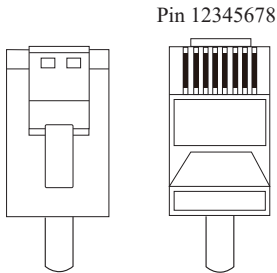

PIN	1	2	3	4	5	6	7	8
Function Description	/	/	RS485_A	RS485_B	/	/	CT1+	CT1-

#### Meter cable connection overview

Inverter	Meter
Pin3 (RS485_A)	Pin24
Pin4 (RS485_B)	Pin25

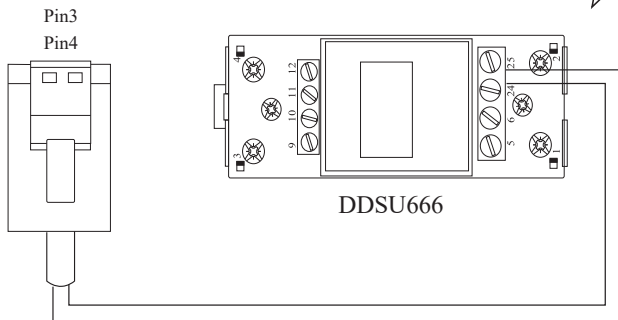
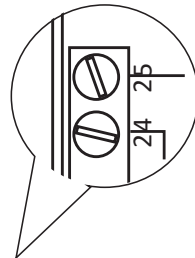

**Connect meter. Refer to the following step:**

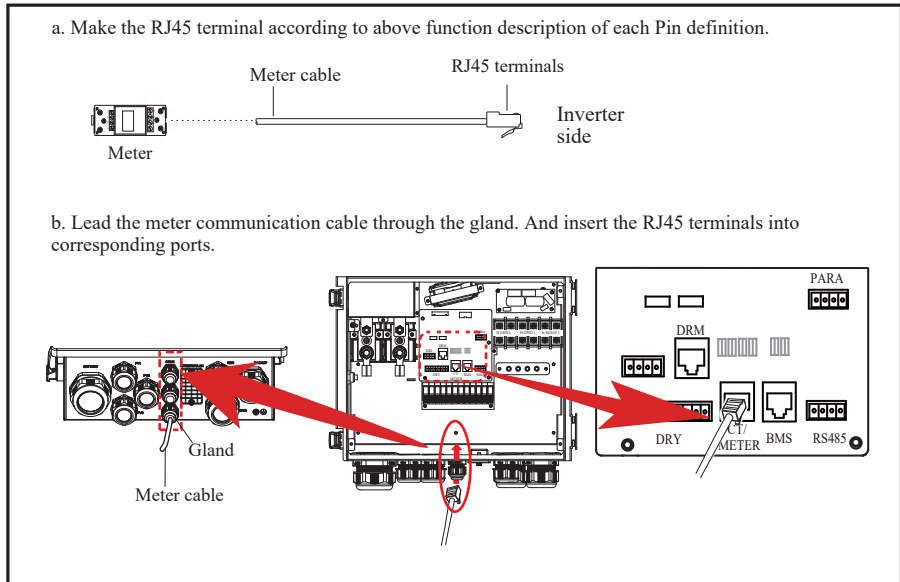

**4.3.3 CT Connection**

This section is applicable to non-parallel connection mode and parallel connection-scheme A only.

**CT cable connection overview**

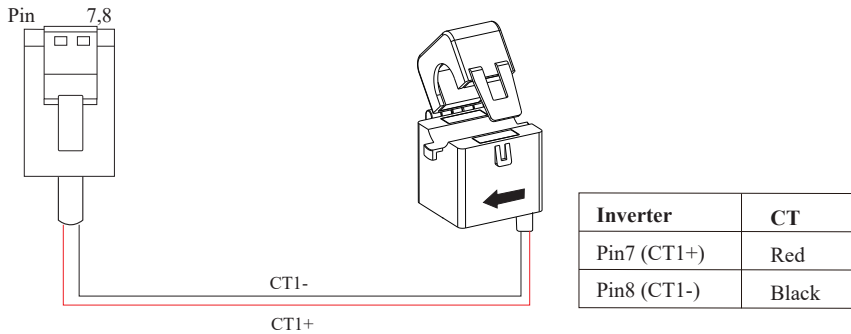

**Connect CT. Refer to the following steps:**

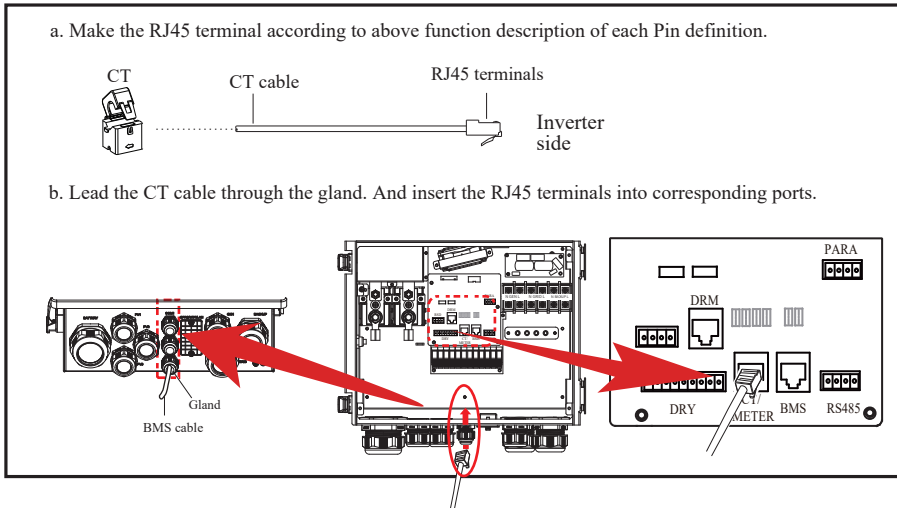

**4.3.4 RS485 Connection**

RS485 communication is usually applied between multiple inverters or between an inverter and a data-logger.

**4-Pin Terminal Configuration of RS485 Communication**



PIN	1	2	3	4
Function Description	RS485_A	RS485_B	PE	PE

**Connect RS485. Refer to the following steps:**

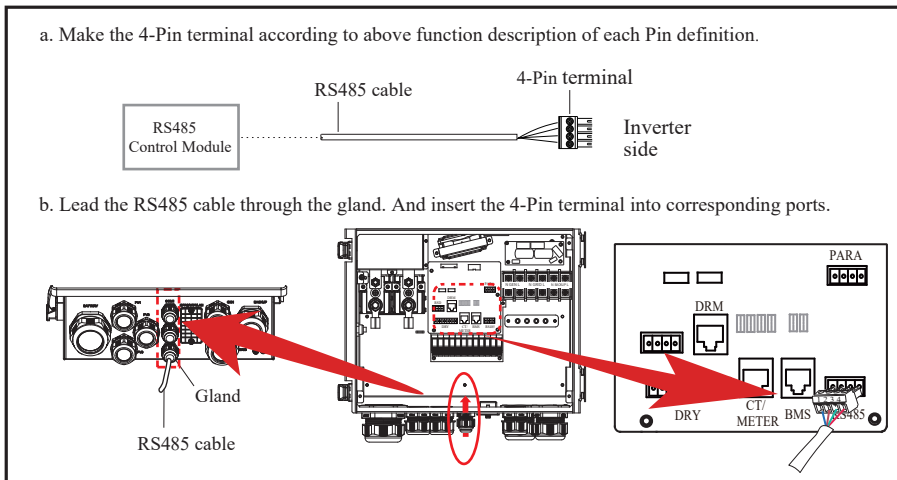

### 4.3.5 Parallel Communication Connection

#### 4-Pin Terminal Configuration of parallel Communication



PIN	1	2	3	4
Function Description	GND_S	PARA_SYNC	CAN_L	CAN_H

#### Parallel communication cable connection overview

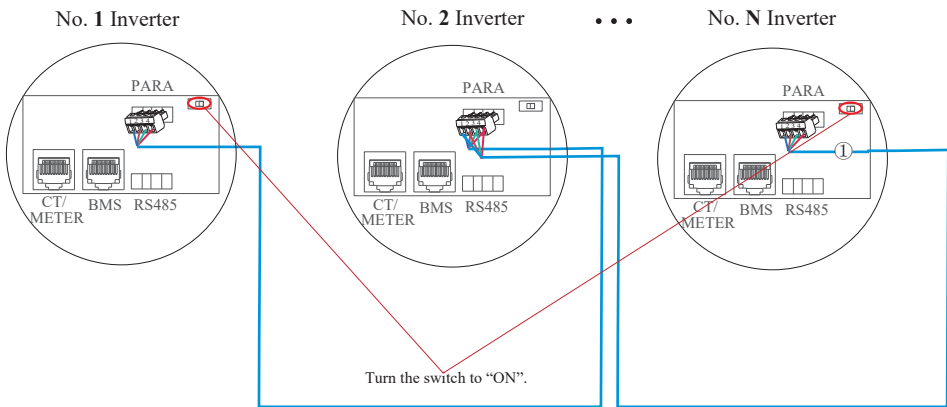

It is necessary to turn the matched resistance switch of No. 1 inverter and No. N inverter to “ON” in parallel connection mode.

No. 1 Inverter	No. 2 Inverter	...	No. N Slave Inverter
Pin4(CAN_H)	Pin4(CAN_H)		Pin4(CAN_H)
Pin3(CAN_L)	Pin3(CAN_L)		Pin3(CAN_L)
Pin2(PARA_SYNC)	Pin2(PARA_SYNC)		Pin2(PARA_SYNC)
Pin1(GND_S)	Pin1(GND_S)		Pin1(GND_S)

**Refer to the following steps:**

- a. Make the 4-Pin terminal according to above function description of each Pin definition.

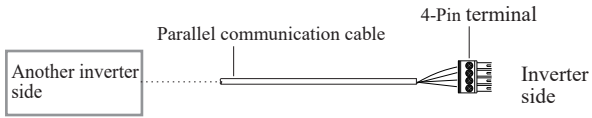

- b. Lead the Parallel communication cable through the gland. And insert the 4-Pin terminal into corresponding ports.

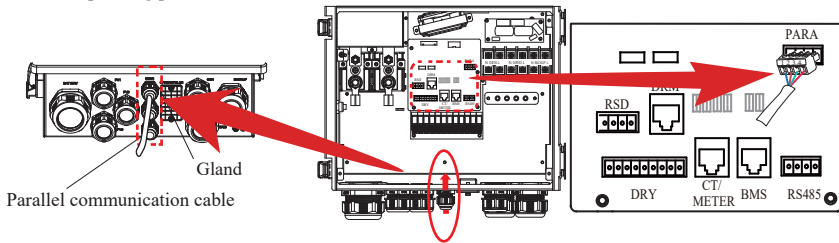

### 4.3.6 NTC/RMO/DRY Connection(s)

#### 9-Pin Terminal Configuration of Auxiliary Communication

Pin 123456789

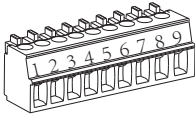

PIN	Function Description
1	GEN Control
2	GEN Control
3	NC1 (Normal Close)
4	NO2 (Normal Open)
5	N2
6	NC2 (Normal Close)
7	Remote OFF
8	GND S
9	NTC BAT+

Refer to the following steps:

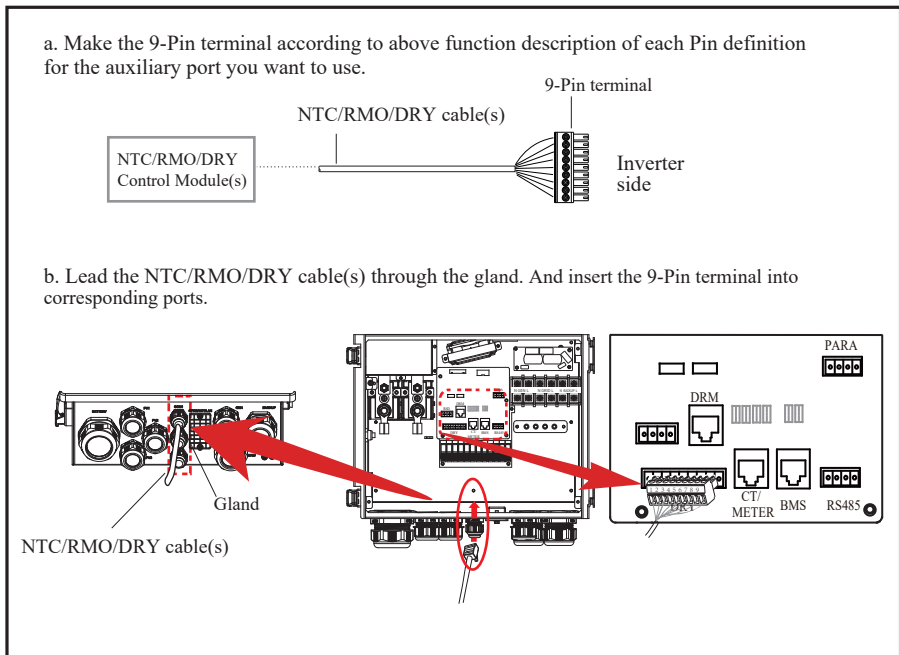

### 4.3.7 GPRS/WIFI/LAN Module Connection (Optional)

For details, please refer to the corresponding Module Installation Guide in the packing.

The appearance of modules may be slightly different. The figure shown here is only for illustration.

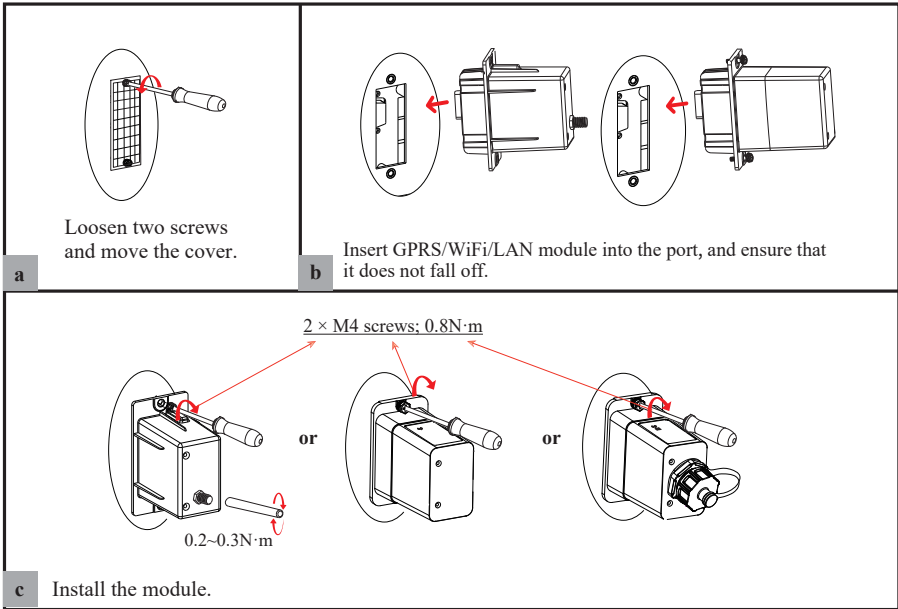

## 5. System Operation

### 5.1 Inverter Working Mode

The inverter supports several different working modes.

#### 5.1.1 Self Used Mode

Go to the "Hybrid work mode" menu, and select the "Self used mode".

Under Self Used mode, the priority of PV energy consumption will be Load > Battery > Grid, that means the energy produced by PV gives priority to powering local loads, the excess energy is used to charge the battery and the remaining energy is fed into the grid.

This is the default mode to increase self-consumption rate. There are several situations of self-used working mode based on PV energy.

##### a) Wealthy PV Energy

When PV energy is wealthy, the PV energy will be first consumed by loads, the excess energy will be used to charge the battery and then the remaining energy will be fed into the grid.

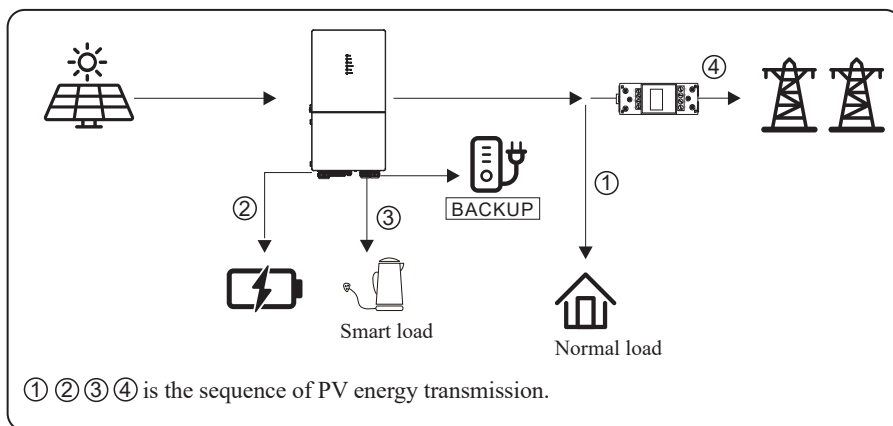

##### b) Limited PV Energy

When the PV energy is not enough to cover all consumption, the PV energy will be entirely used by loads, and the insufficient part will be supplied by battery. Then still insufficient parts will be supplied by grid.



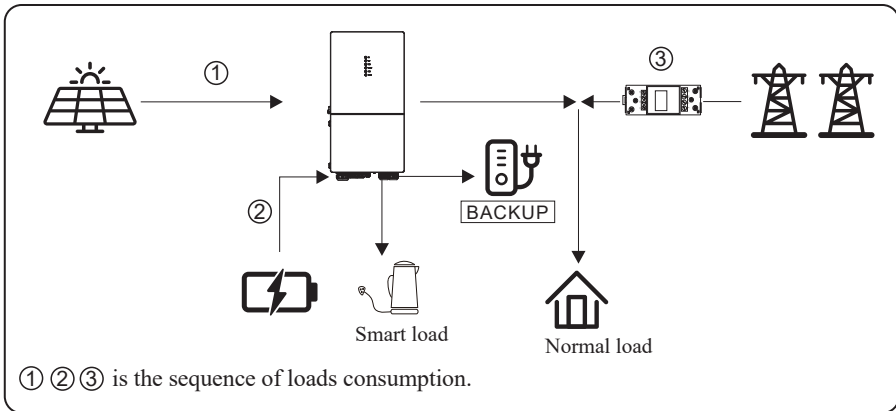

### c) No PV Input

The inverter will first discharge the battery energy for home load consuming when no PV input (such as in the evening or some cloudy or rainy days). If the demand is not met, the loads will consume grid energy.

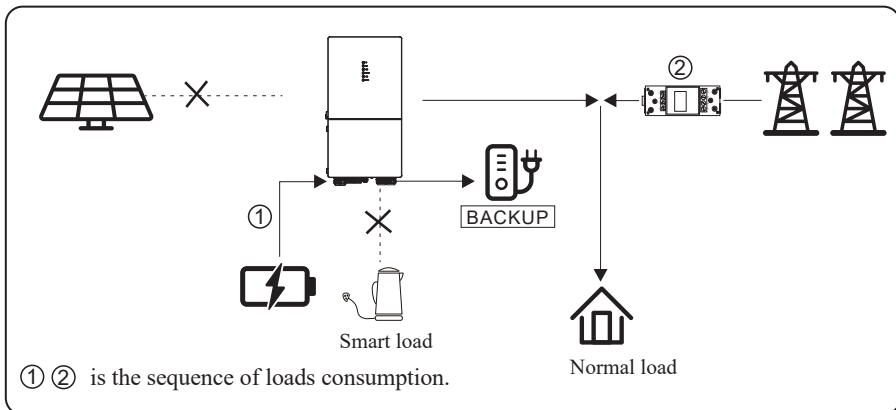

### 5.1.2 Feed-in Priority Mode

Go to the "Hybrid work mode" menu, and select the "Feed-in priority mode".

Under this mode, the priority of PV energy consumption will be Load > Grid > Battery, that means the energy produced by PV gives priority to powering local loads, the excess energy is fed into the grid, and the remaining energy is used to charge the battery.

### a) Wealthy PV Energy

When PV energy is wealthy, the PV energy will be first consumed by loads. If there is excess PV power, the power will be fed into grid. If there is still PV energy left after load consuming and grid feeding, then the remaining PV power will be used to charge the battery.

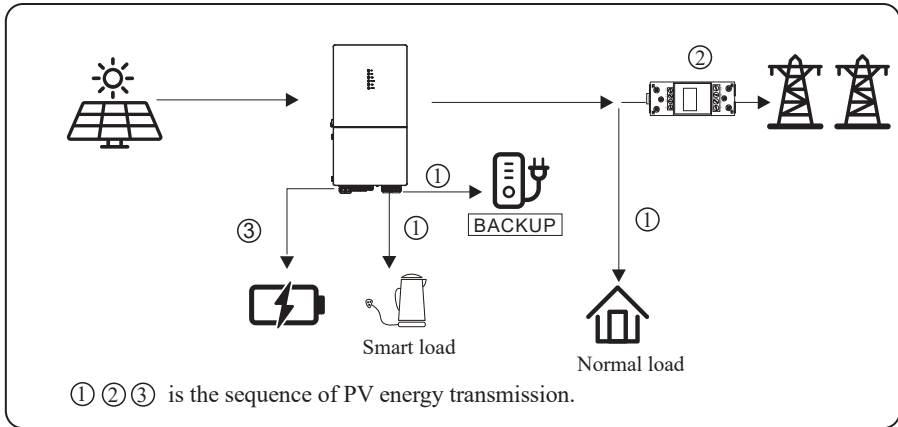

### b) Limited PV Energy

When PV energy is limited and can not meet the feed-in grid power, the battery will discharge to meet it.

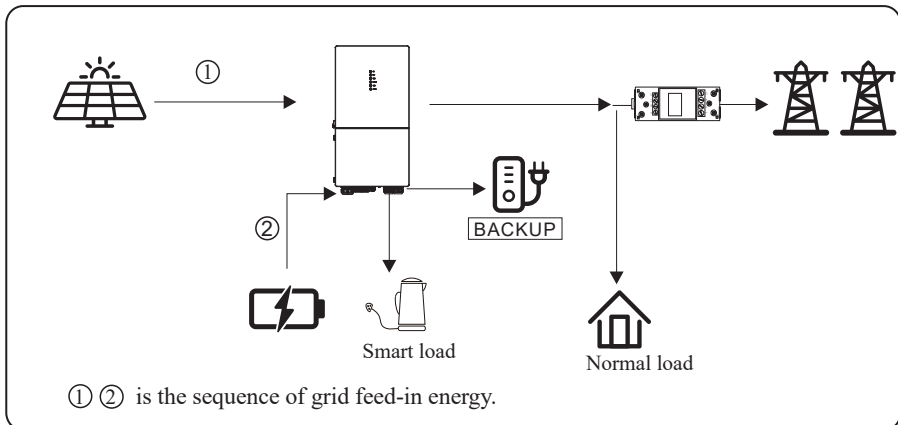

### c) No PV Input

The inverter will first discharge the battery energy for home load consuming when no PV input (such as in the evening or some cloudy or rainy days). If the demand is not met, the loads will consume the grid energy.

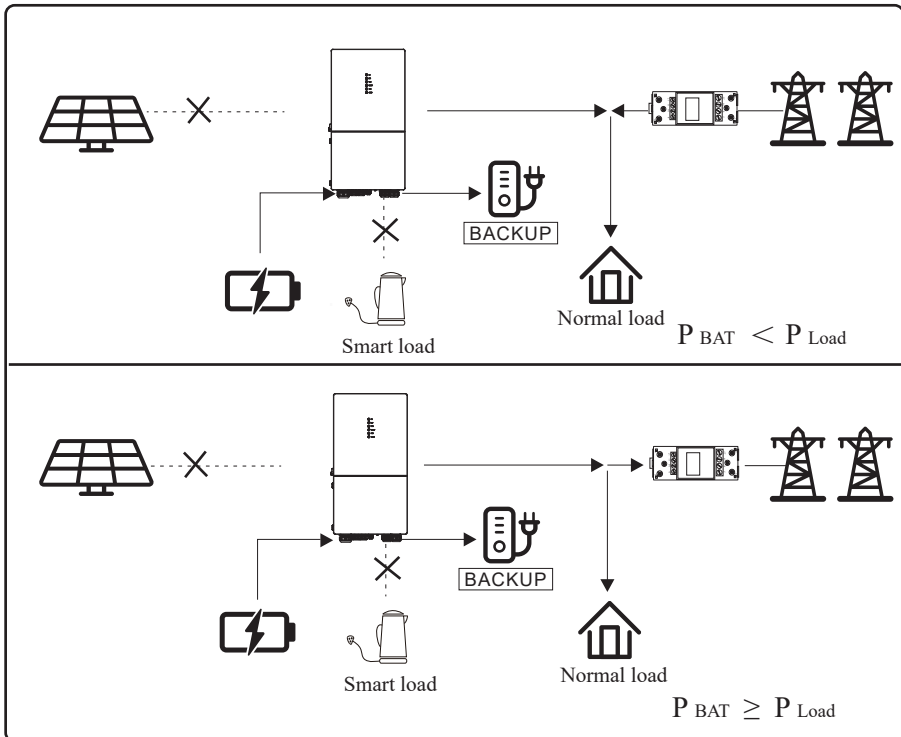

#### 5.1.3 Time-Based Control Mode

Go to the "Hybrid work mode" menu, and select the "Time-based Control".

Under this mode, you can control the charging and discharging of the inverter. You can set the following parameters based on your requirements:

- Charge and discharge frequency: one time or daily
- Charging start time: 0 to 24 hours
- Charging end time: 0 to 24 hours
- Discharge start time: 0 to 24 hours
- Discharge end time: 0 to 24 hours

You can also choose whether to allow the grid to charge the battery, which is prohibited by default. If the user enables the "Grid charge function", the "Maximum grid charger power" and "Capacity of grid charger end" can be set. When the battery capacity reaches the set value, the grid will stop charging the battery.

### 5.1.4 Back-up Mode

Go to the "Hybrid work mode" menu, and select the "Back-up Mode".

Under this mode, the priority of PV energy consumption will be Battery > Load > Grid.

This mode aims at charging the battery quickly, and at the same time, you can choose whether to allow AC to charge the battery.

#### Forbid AC charging

In this mode, the battery can be charged only with PV power, and the charging power varies with PV power.

#### a) Wealthy PV power

When PV energy is wealthy, PV charges the battery first, then meets the load, and the rest is fed into the grid.

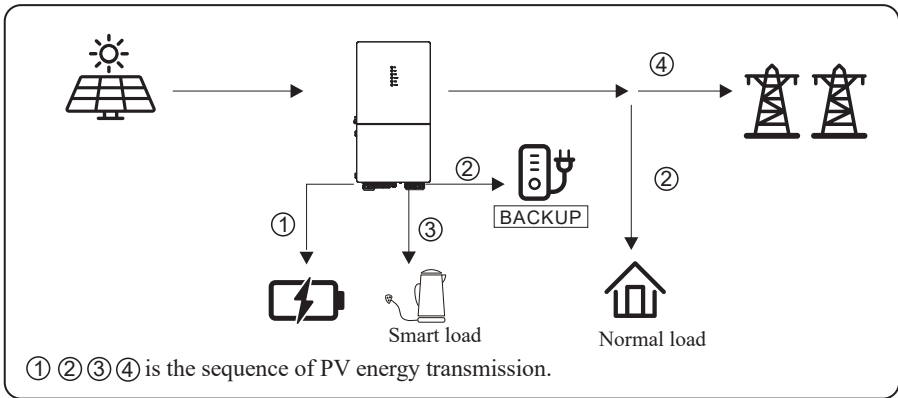

#### b) Limited PV power

When PV energy is limited, PV gives priority to charging the battery, and the grid directly meets the load demand.

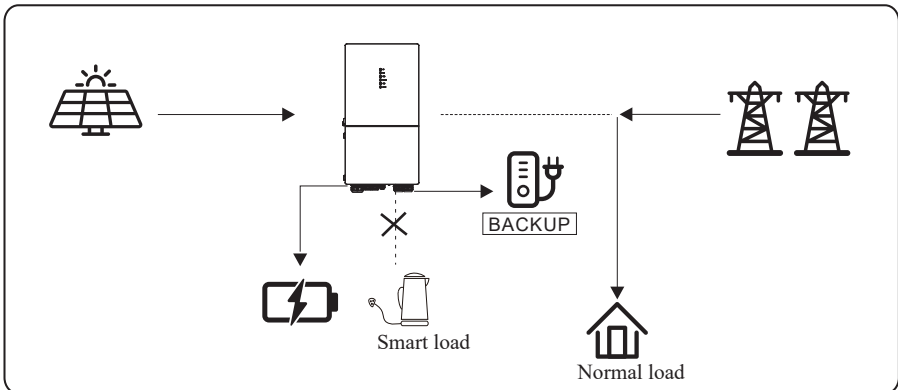

**Allow AC charging**

In this situation, the battery can be charged both with PV and AC.

**a) Wealthy PV power**

When PV energy is wealthy, PV charges the battery first, then meets the loads, and the rest is fed into the grid.

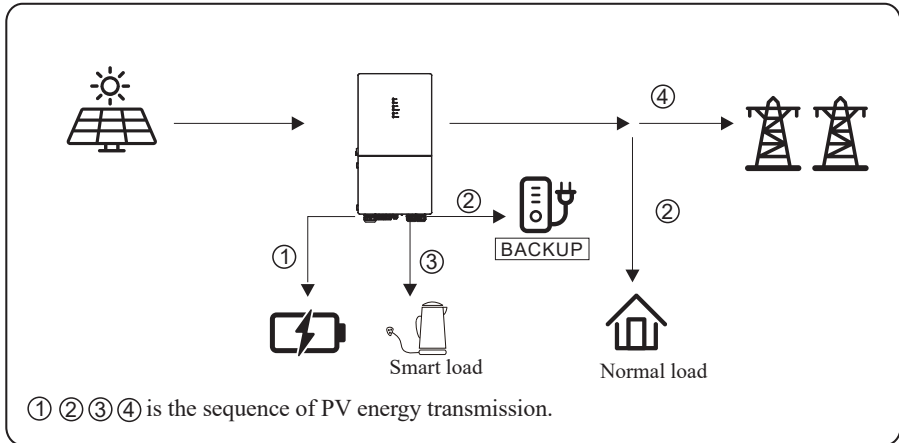

**b) Limited PV power**

When the PV energy is not enough to charge the battery, the grid energy will charge the battery as supplement. Meanwhile, the grid energy is consumed by loads.

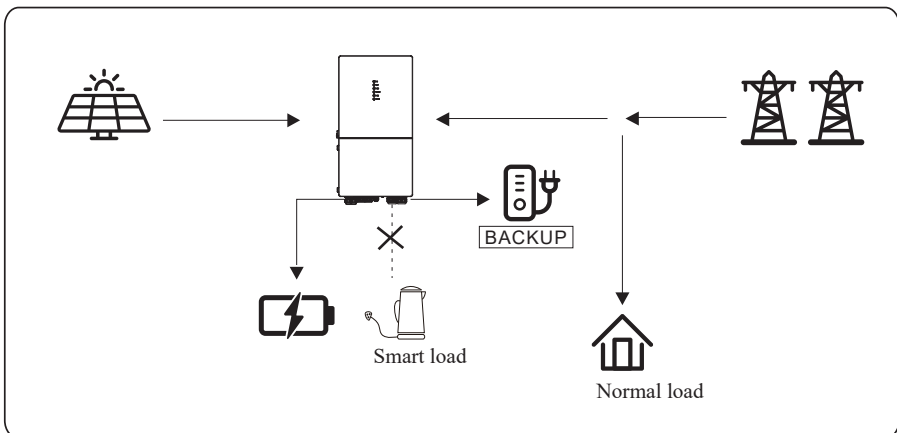

### 5.1.5 Off Grid Mode

When the power grid is cut off, the system automatically switches to Off Grid mode.

Under off-grid mode, only critical loads are supplied to ensure that important loads continue to work without power failure.

Under this mode, the inverter can't work without the battery.

#### a) Wealthy PV power

When PV energy is wealthy, the PV power will be first consumed by critical load, then charge the battery.

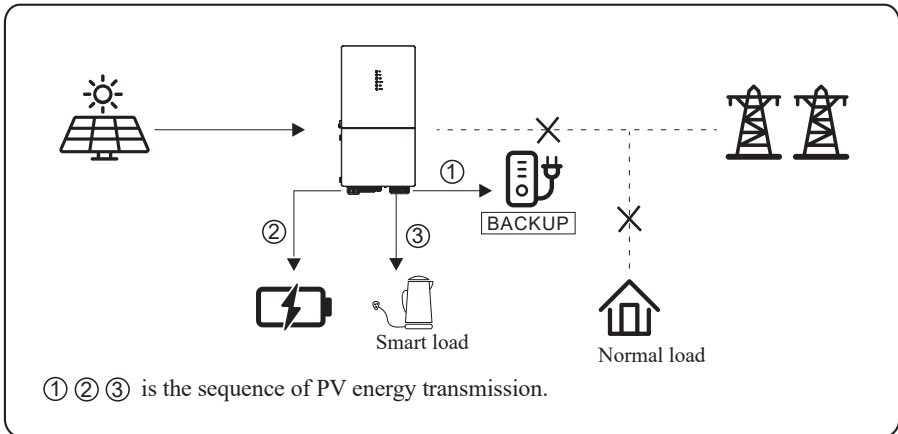

### b) Limited PV power

When PV energy is limited, BACKUP loads are first powered by PV and then supplemented by battery.

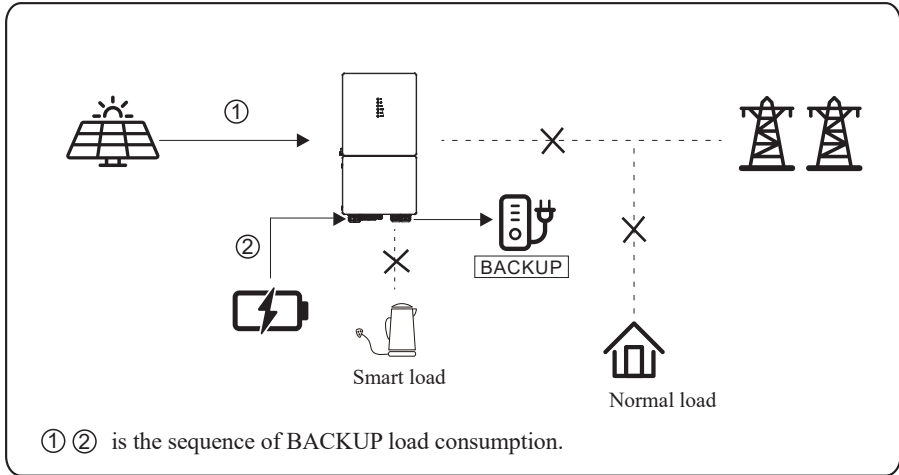

#### NOTICE

- Under this mode, please complete the output voltage and frequency settings.
- It is better to choose the battery capacity greater than 100Ah to ensure BACKUP function works normally.
- If BACKUP output loads are inductive or capacitive loads, to make sure the stability and reliability of system, it is recommended to configure the power of these loads to be within 50% of BACKUP output power range.

## 5.2 Startup/Shutdown Procedure

### 5.2.1 Startup Procedure

Check that the installation is secure and strong enough, and that the system is well grounded. Then confirm the connections of AC, battery, PV etc. are correct. Confirm the parameters and configurations conform to relevant requirements.

AC Frequency	50/60Hz	PV Voltage	70~540V
Battery Voltage	40~64V	Grid AC Voltage	220V/230V/240V (Single phase)

Make sure all the above aspects are right, then follow the procedure to start up the inverter:

- 1) Power on the PV.
  - 2) Power on the battery.
  - 3) Power on the AC.
  - 4) Power on the BACKUP.
  - 5) Connect the cell phone App via Bluetooth. Please refer to Section 7.2 for details.
  - 6) Click the Power ON in the App for the first time. Please refer to Section 7.2 for details.
- And you can press the ON/OFF button on the side of the inverter for 5 seconds in this step when performing subsequent startup.

### 5.2.2 Shutdown Procedure

According to actual situation, if there is a must to shut-down the running system, please follow below procedure:

- 1) Connect the cell phone App via Bluetooth. Please refer to Section 7.2 for details.
- 2) Click the Power OFF on the App. Please refer to Section 7.2 for details. Or you can press the ON/OFF button on the side of the inverter for 5 seconds in this step when performing subsequent startup.
- 3) Power off the BACKUP.
- 4) Power off the AC.
- 5) Power off the Battery.
- 6) Power off the PV.
- 7) If you need to disconnect the inverter cables, please wait at least 5 minutes before touching these parts of inverter.



## 6. Commissioning

It is necessary to make a complete commissioning of the inverter system. This will essentially protect the system from fire, electric shock or other damages or injuries.

### 6.1 Inspection

Before commissioning, the operator or installer (qualified personnel) must inspect the system carefully and make sure:

- 1) The system is firmly and correctly installed by following the contents and notifications of this manual, and there are enough spaces for operation, maintenance and ventilation.
- 2) All the terminals and cables are in good status without any damages.
- 3) No items are left on the inverter or within the required clearance section.
- 4) The PV, battery pack is working normally, and grid is normal.

### 6.2 Commissioning Procedure

After inspection and making sure status is right, then start the commissioning of the system.

- 1) Power on the system by referring to the Startup section 5.2.1.
- 2) Setting the parameters on the App according to user's requirement.
- 3) Finish commissioning.

## 7. User Interface

### 7.1 LED

This section describes the LED panel. LED indicator includes PV, BAT, GRID, BACKUP, COM, ALARM indicators.

It includes the explanation of indicator states and summary of indicator states under the running state of the machine.



LED Indicator	Status	Description
PV	On	PV input is normal.
	Blink	PV input is abnormal.
	Off	PV is unavailable.
BAT	On	Battery is charging.
	Blink	Battery is discharging. Battery is abnormal.
	Off	Battery is unavailable.
GRID	On	GRID is available and normal.
	Blink	GRID is available and abnormal.
	Off	GRID is unavailable.
COM	On	Communication is ok.
	Off	Power supply is unavailable.
BACKUP	On	BACKUP power is available.
	Blink	BACKUP output is abnormal.
	Off	BACKUP power is unavailable.
ALARM	On	Fault has occurred and inverter shuts down.
	Blink	Alarms has occurred but inverter doesn't shut down.
	Off	No fault.

Details	Code	PV LED	Grid LED	BAT LED	BACKUP LED	COM LED	ALARM LED
PV normal		●	⊙	⊙	⊙	⊙	○
No PV		○	⊙	⊙	⊙	⊙	○
PV over voltage	B0						
PV under voltage	B4						
PV irradiation weak	B5	★	⊙	⊙	⊙	⊙	○
PV string reverse	B7						
PV string abnormal	B3						
On grid		⊙	●	⊙	⊙	⊙	○
Grid over voltage	A0						
Grid under voltage	A1						
Grid absent	A2						
Grid over frequency	A3	⊙	★	⊙	⊙	⊙	○
Grid under frequency	A4						
Grid abnormal	A6						
Grid over mean voltage	A7						
Neutral live wire reversed	A8						
Battery in charge		⊙	⊙	●	⊙	⊙	○
Battery absent	D1	⊙	⊙	○	⊙	⊙	○
Battery in discharge		⊙	⊙	★★	⊙	⊙	○
Battery under voltage	D3						
Battery over voltage	D2						
Battery discharge over current	D4	⊙	⊙	★	⊙	⊙	○
Battery over temperature	D5						
Battery under temperature	D6						
Communication loss (Inverter - BMS)	D8						
BACKUP output active		⊙	⊙	⊙	●	⊙	⊙
BACKUP output inactive		⊙	⊙	⊙	○	⊙	⊙
BACKUP short circuit	DB						
BACKUP over load	DC						
BACKUP output voltage abnormal	D7	⊙	⊙	⊙	★	⊙	○
BACKUP over dc-bias voltage	CP						

Details	Code	PV LED	Grid LED	BAT LED	BACKUP LED	COM LED	ALARM LED
RS485/DB9/BLE/USB		☉	☉	☉	☉	●	☉
Inverter over temperature	C5						
Fan abnormal	C8						
Inverter in power limit state	CL						
Data logger lost	CH	☉	☉	☉	☉	☉	★
Meter lost	CJ						
Remote off	CN						
PV insulation abnormal	B1						
Leakage current abnormal	B2						
Internal power supply abnormal	C0						
Inverter over dc-bias current	C2						
Inverter relay abnormal	C3						
GFCI abnormal	C6						
System type error	C7						
Unbalance Dc-link voltage	C9						
Dc-link over voltage	CA	☉	☉	☉	☉	☉	●
Internal communication error	CB						
Internal communication loss(E-M)	D9						
Internal communication loss(M-D)	DA						
Software incompatibility	CC						
Internal storage error	CD						
Boost abnormal	CG						
Dc-dc abnormal	CU						

Remark: ● Light on      ○ Light off      ☉ Keep original status  
 ★ Blink 1s and off 1s      ★★ Blink 2s and off 1s

## 7.2 App Setting Guide

### 7.2.1 Download App

- Scan the QR code on the inverter to download the APP.
- Download the APP from the App Store or Google Play.

The APP should access some permissions such as the device’s location. You need to grant all access rights in all pop-up windows when installing the APP or setting your phone.

### 7.2.2 App Architecture

It contains “Cloud Login” and “Local Connection”.

- Cloud login: APP read data from cloud server through API and display inverter parameter
- Local connection: APP read data from inverter through Bluetooth connection with Modbus protocol to display and configure inverter parameter.

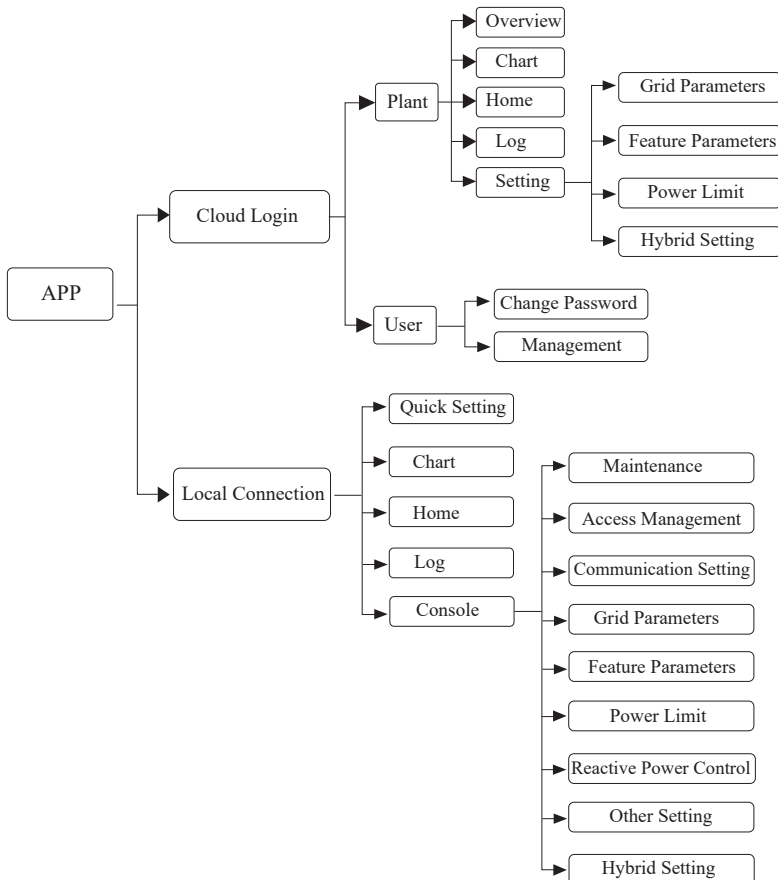

### 7.2.3 Local Setting

#### ■ Access Permission

Before using the local setting, the APP should access some permissions. (You can allow them when you install the APP or grant permissions in your own phone setting.) When the APP asks for permission, please click Allow.

#### ■ Connect Inverter

Firstly, open the Bluetooth on your own phone, then open the APP.

Press Local Setting to go to the connect page. This page shows the inverters which you can connect or you have connected. (As shown below) Press the inverter's name to connect it.



■ Quick Setting

1. Connect to the router.

Step 1 Go to Quick Setting page.

Step 2 Click each item to enter the information, then click [Next](#).

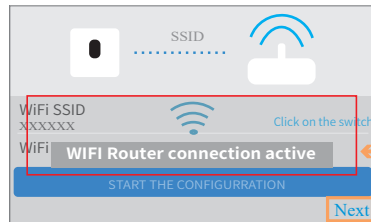
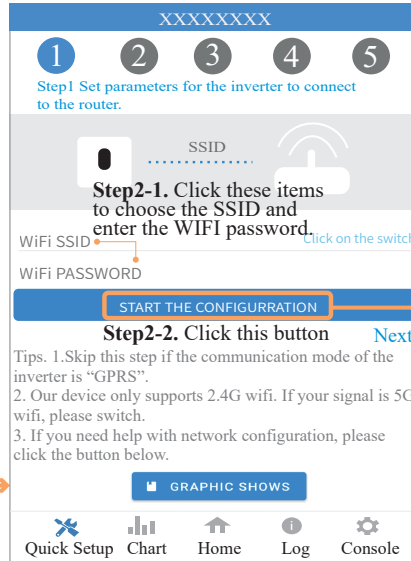
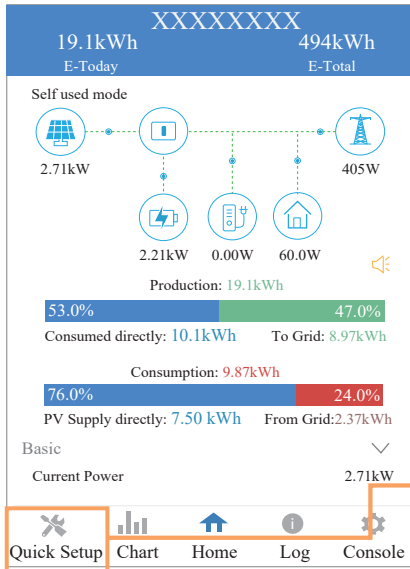

2. Set parameters of power grid

Step 1 Click each item to enter the parameters of power grid.

Step 2 Click [Next](#).

Step 3 Click [Previous](#) back to the previous page.

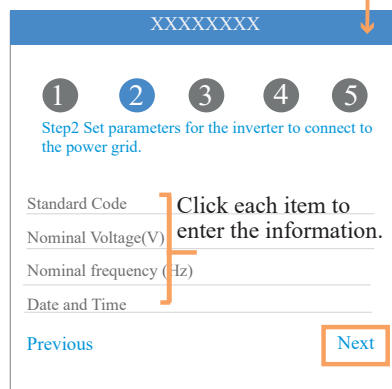

3. Set parameters of power limit

Step 1 Click each item to enter the parameters of power limit.

Step 2 Click [Next](#).

Step 3 Click [Previous](#) back to the previous page.

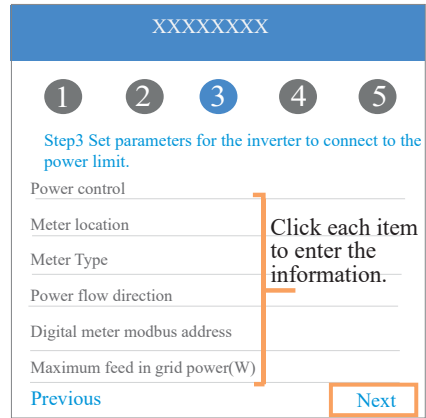

4. Set parameters of work mode

Step 1 Click each item to enter the information of work mode.

Step 2 Click [Next](#).

Step 3 Click [Previous](#) back to the previous page.

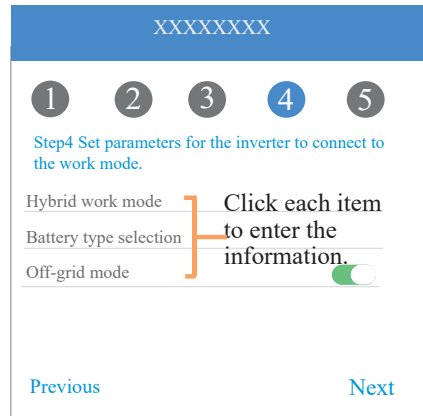

5. Start Inverter

Step 1 Click .

Step 2 Click [Previous](#) back to the previous page.





## ■ APP Power Chart

The power chart is showed by Day, Month and Year in our APP. For each exhibition method, it includes both Production and Consumption. We use different icons and colors for different power messages. The icon and color definition as below:



Color: Blue

Definition: Load consumption only from PV



Color: Red

Definition: Battery charge power with PV or AC



Color: Red

Definition: Battery discharge power for load consumption or feed-in grid



Color: Purple

Definition: Consumption power from grid



Color: Purple

Definition: Feed-in grid power from PV or battery



Color: Orange

Definition: Load power



Color: Orange

Definition: PV generating power

### 1. Query (Daily) Data

Go to [Chart](#) > [Day](#) page. It will show the Daily Production or Consumption Curve in this page. You can swipe the screen left and right to switch the graph.

#### ● Day Chart--Production



The above combination day chart shows the PV production power distributed with three parts:

- load consumption power (Blue)
- battery charge power (Red)
- feed-in grid power (Purple)

- Day Chart--Consumption

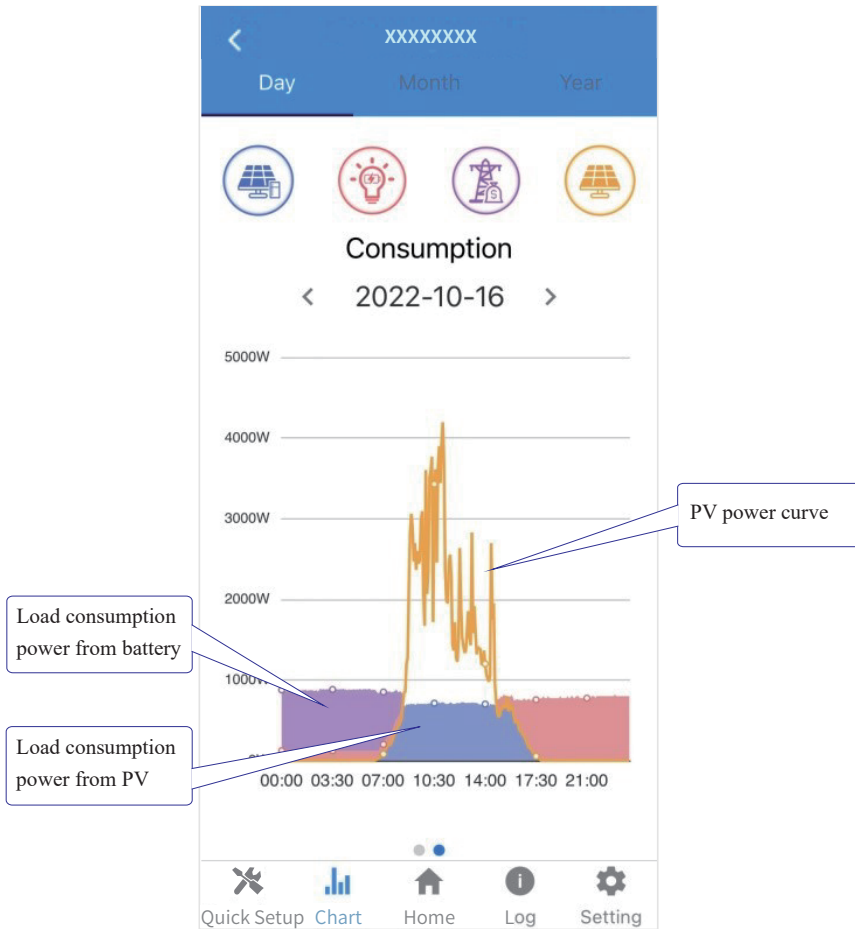

The above combination day chart shows the load consumption power from three parts:

- PV generation power (Blue)
- battery discharge power (Red)
- grid power (Purple)

Power supported by PV + power supported by battery + power supported by grid = Load consumption power.

## 2. Query (Monthly) Data

Go to [Chart](#) > [Month](#) page. It will show the Monthly Production or Consumption Curve in this page. You can swipe the screen left and right to switch the graph.

### ● Month Chart--Production

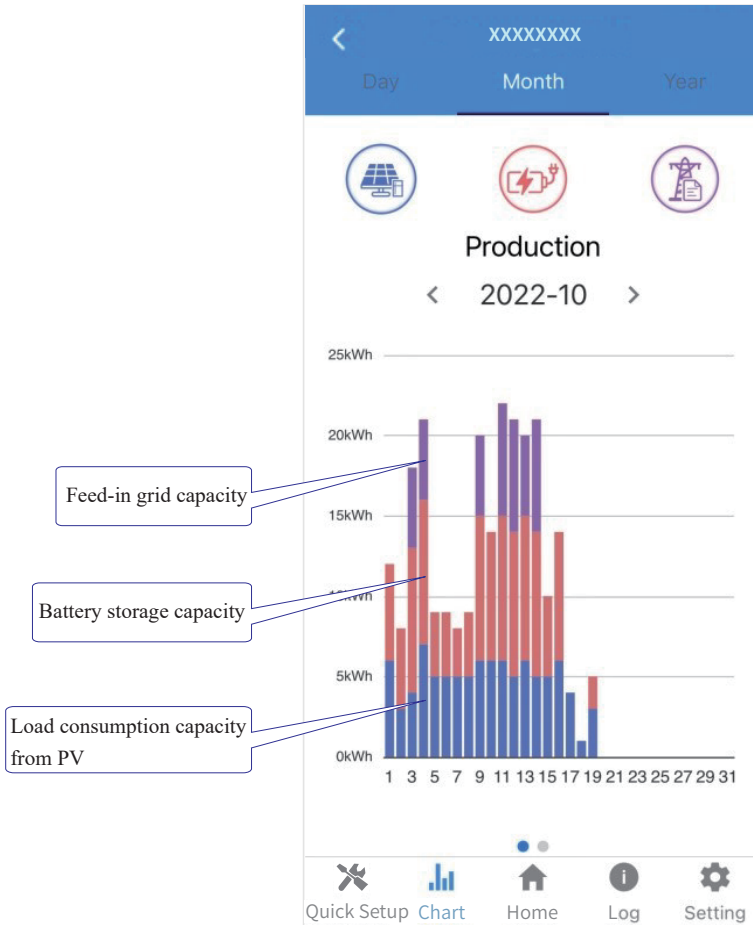

The above combination day chart shows the load consumption power from three parts:

- load consumption capacity (Blue)
- battery storage capacity (Red)
- feed-in grid capacity (Purple)

- Month Chart--Consumption

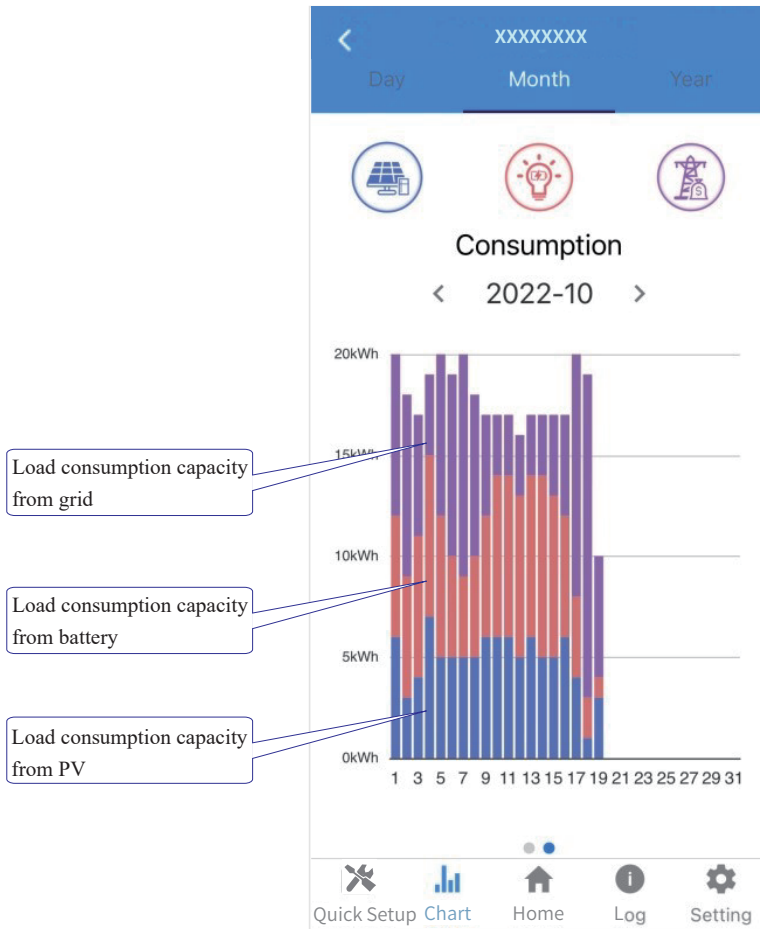

The above combination month chart shows the load consumption capacity from three parts:

- PV generation capacity (Blue)
- battery discharge capacity (Red)
- grid capacity (Purple)

## 2. Query (Yearly) Data

Go to [Chart](#) > [Year](#) page. It will show the Annually Production or Consumption Curve in this page. You can swipe the screen left and right to switch the graph.

### ● Year Chart--Production



The above combination year chart shows the distribution of PV production capacity with three parts:

- load consumption capacity (Blue)
- battery storage capacity (Red)
- feed-in grid capacity (Purple)

- Year Chart--Consumption

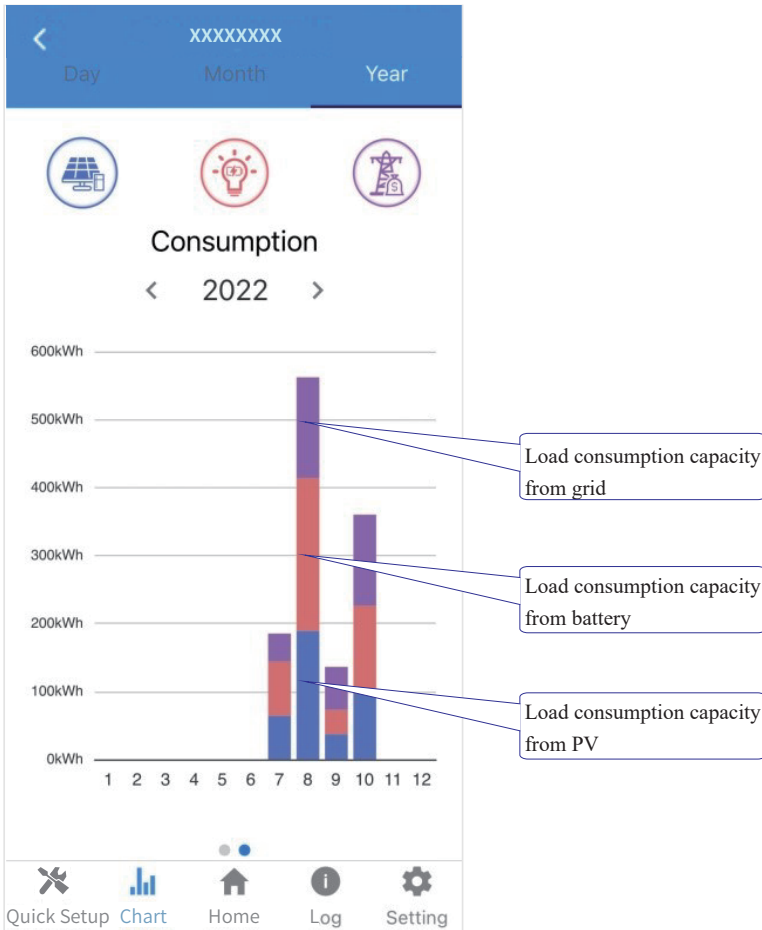

The above combination year chart shows the load consumption capacity from three parts:

- PV generation capacity (Blue)
- battery discharge capacity (Red)
- grid capacity (Purple)

### Local Setting Homepage

This page shows the basic information of inverter. Click  to display the warning message.

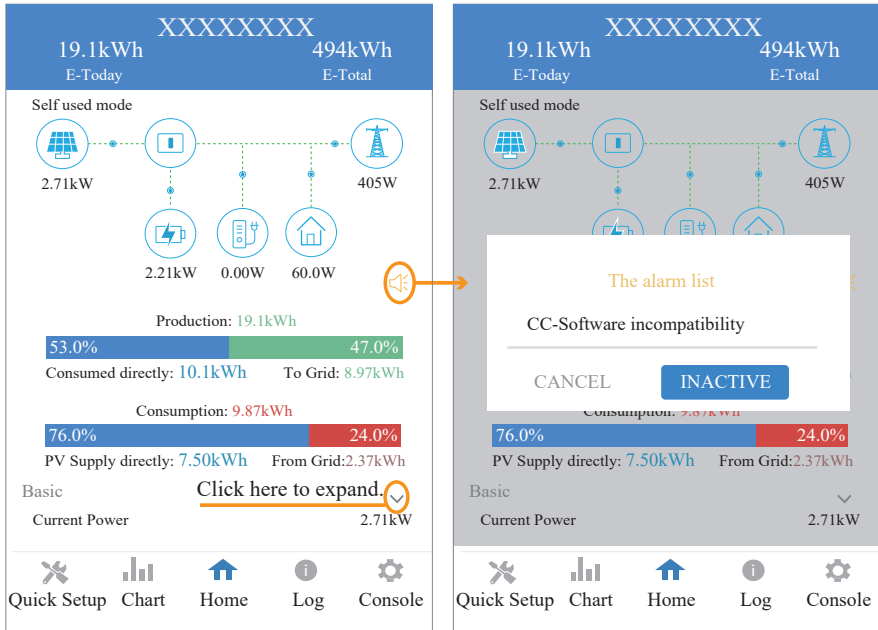

### History Log

Press **Log** at the bottom and then go to the history log page (as shown below). It contains all the logs for the inverter.

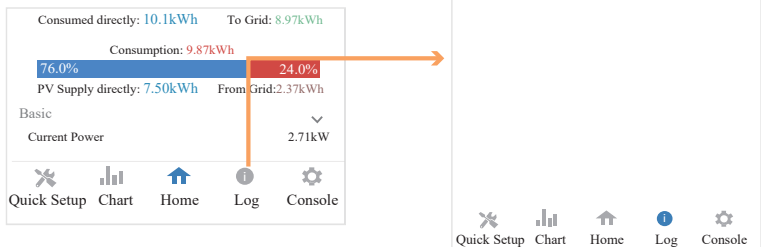



### ■ Maintenance

Go to [Console](#) page. And click [Maintenance](#)

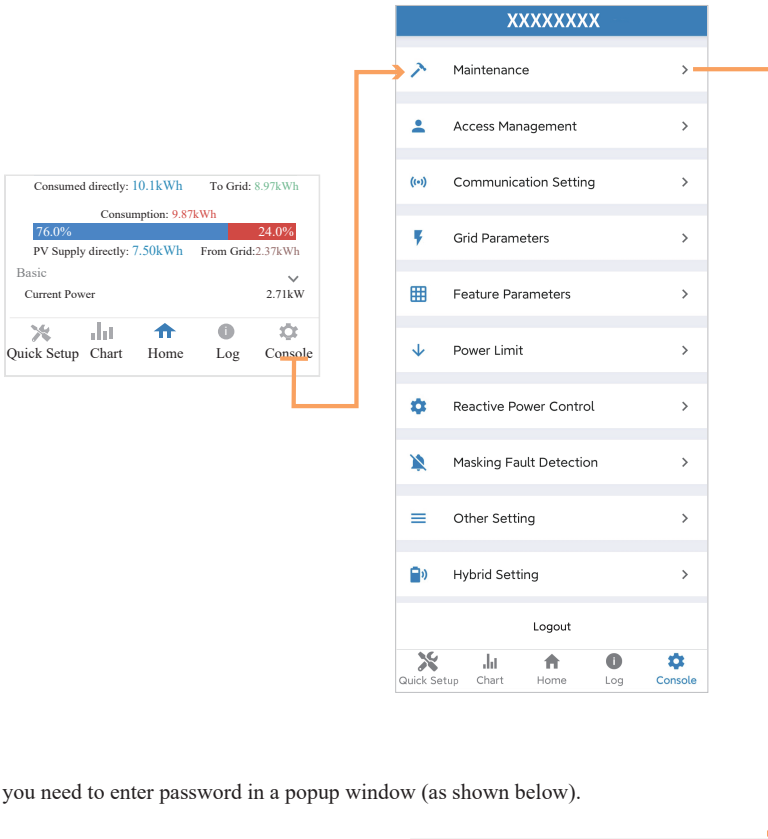

Then you need to enter password in a popup window (as shown below).

### Login As Administrator

Enter administrator password

**CANCEL** **OK**

In this page, you can view the basic information like some version information, do some maintaining operations like turn off/on the inverter and manage data.

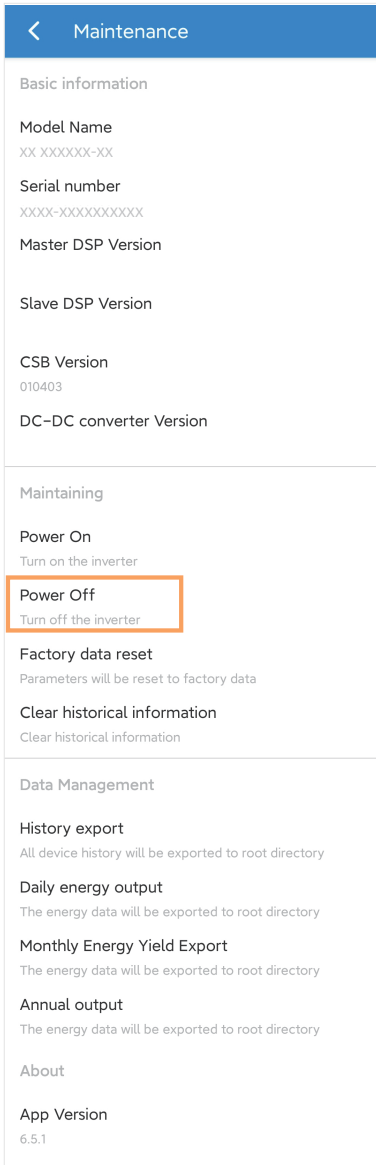

## ■ Console

### Access Management

Go to [Console](#) > [Access Management](#) page. In this page, you can switch the login permission.

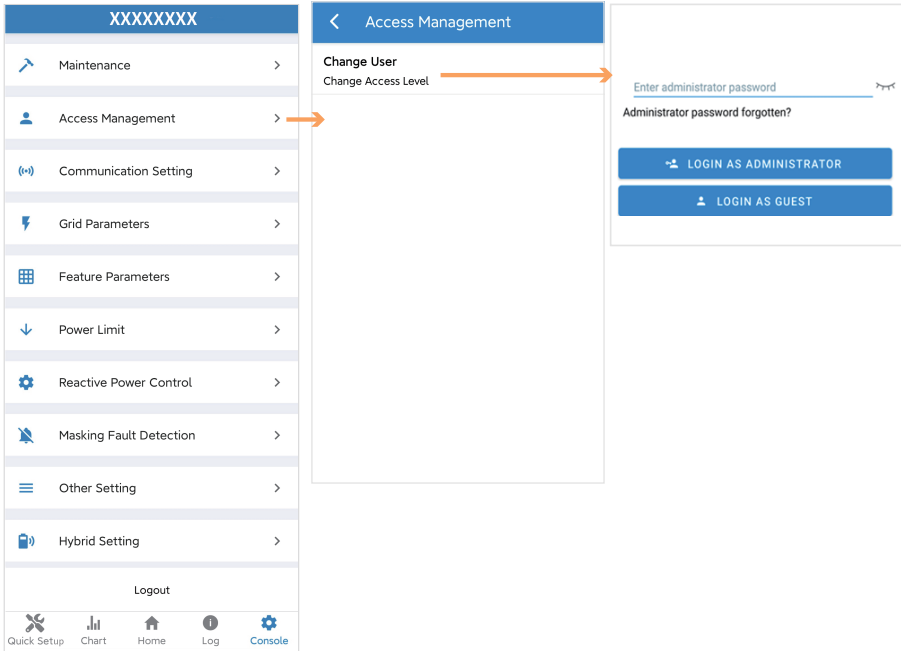

### Communication Setting

Go to [Console > Communication Setting](#) page. In this page, you can set or change the parameters of communication settings: Basic Setting, RS485 Setting and Ethernet Setting.

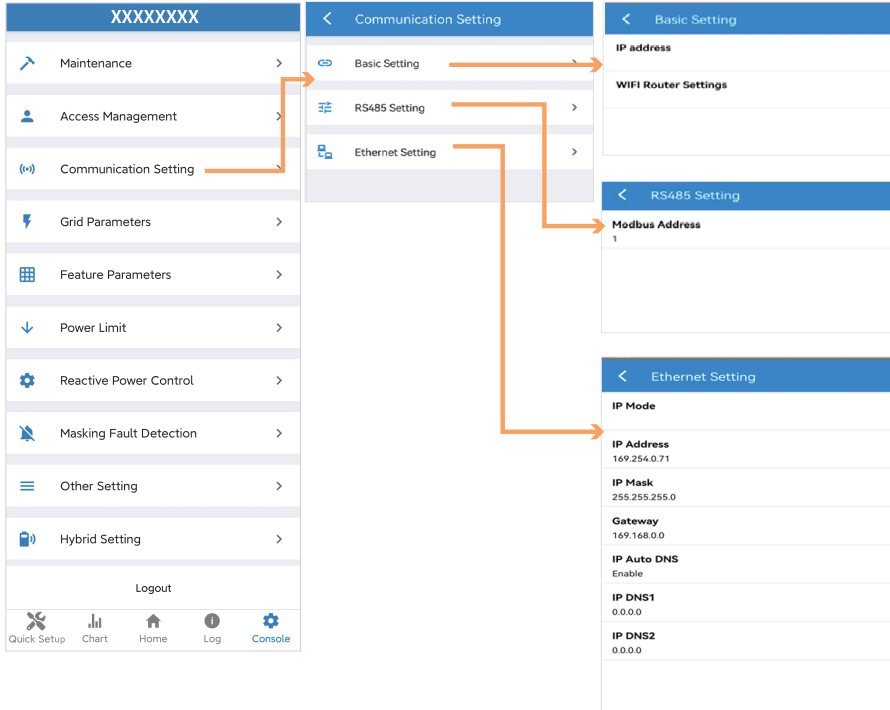

### Grid Parameters

Go to [Console](#) > [Grid Parameters](#) page. In this page, you can set or change the parameters of Grid side, as shown in the figure.

### Feature Parameters

Go to [Console](#) > [Feature Parameters](#) page. In this page, you can set or change the feature parameters, as shown in the figure.

### Power Limit

Go to [Console](#) > [Power Limit](#) page. In this page, you can set or change the parameters of power limit, as shown in the figure.

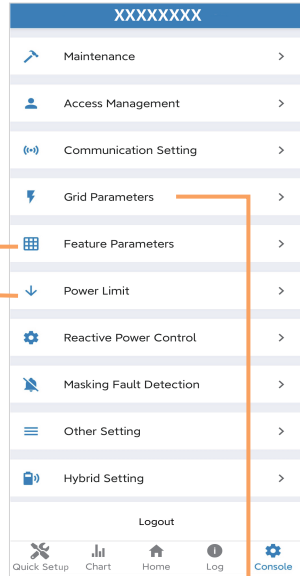

Power Limit	
<b>Power control</b> Digital Power Meter	
<b>Meter location</b> On Grid	
<b>Meter Type</b> CHINT/DTSU666	
<b>Power flow direction</b> From grid to inverter	
<b>Digital meter modbus address</b> 200	
<b>Maximum feed in grid power(W)</b> 70000	

Feature Parameters	
Low Voltage Through	<input type="checkbox"/>
Island Detection	<input type="checkbox"/>
Isolation Detection	<input type="checkbox"/>
Leakage Current Detection(GFCI)	<input type="checkbox"/>
Terminal Resistor	<input type="checkbox"/>
Derated Power(%) 0	
Power Factor 0.00	
Insulation Impedance(kΩ)	
Leakage Current Point(mA)	
Unbalanced Voltage Point(%)	
Moving Average Voltage Limit(V) 0	

Grid Parameters	
<b>Standard Code</b> Unknown	
<b>First Connect Delay Time(s)</b>	
<b>Reconnect Delay Time (s)</b>	
<b>Frequency High Loss Level_1(Hz)</b> 0	
<b>Frequency Low loss Level_1(Hz)</b> 0	
<b>Voltage High Loss Level_1(V)</b> 0	
<b>Voltage Low Loss Level_1(V)</b> 0	
<b>Frequency High Loss Time Level_1(ms)</b> 0	
<b>Frequency Low loss Time Level_1(ms)</b> 0	
<b>Voltage High Loss Time Level_1(ms)</b> 0	
<b>Voltage Low Loss Time Level_1(ms)</b> 0	
<b>Frequency High Loss Level_2(Hz)</b> 0	
<b>Voltage High Loss Level_2(V)</b> 0	
<b>Frequency High Loss Time Level_2(ms)</b> 0	
<b>Voltage High Loss Time Level_2(ms)</b> 0	

### Reactive Power Control

Go to [Console > Reactive Power Control](#) page. In this page, you can set or change the Reactive Power Control parameters.

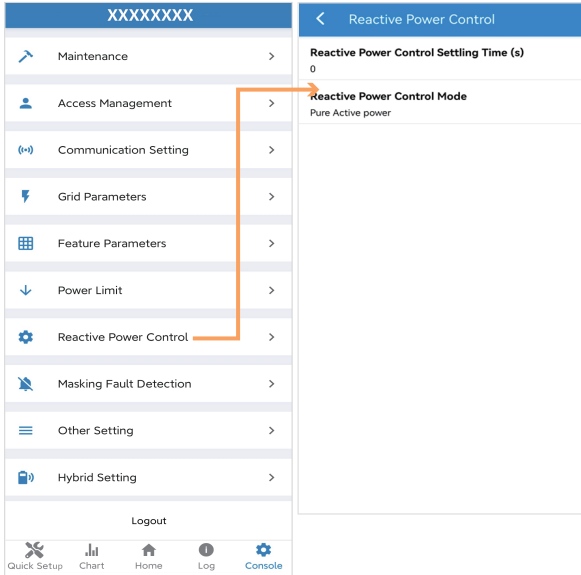

### Other Setting

Go to [Console > Other Setting](#) page. In this page, you can set other setting parameters.

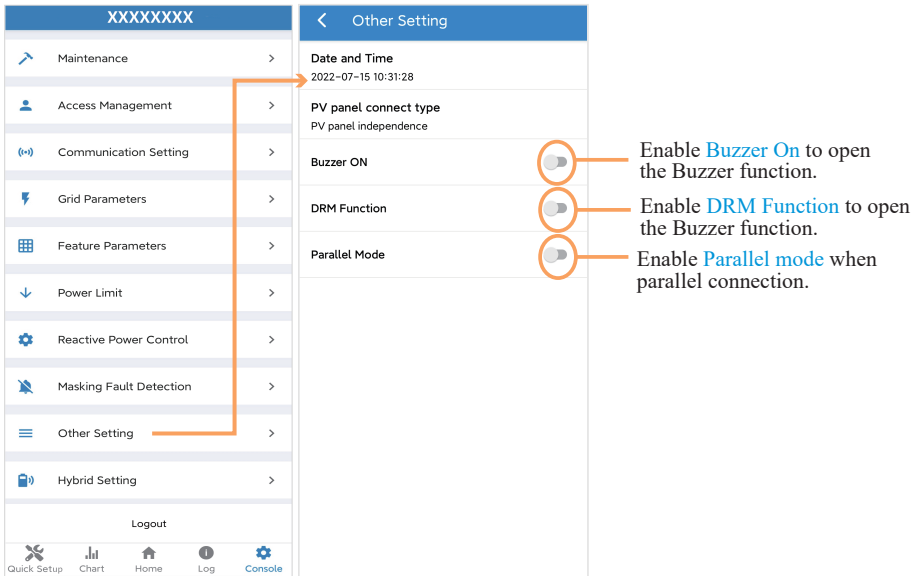

## Hybrid Setting

Go to [Console > Hybrid Setting](#) page. In this page, you can set Hybrid Setting parameters.

XXXXXXX	< Hybrid Setting
Maintenance >	<b>Hybrid work mode</b> Self used mode
Access Management >	<b>Battery type selection</b> Unavailable
Communication Setting >	<b>Maximum charger power(W)</b> 0
Grid Parameters >	<b>Capacity of charger end(%)</b> 0
Feature Parameters >	<b>Maximum discharger power(W)</b> 555
Power Limit >	<b>Capacity of discharger end(%)</b> 0
Reactive Power Control >	<b>EPS Output</b> <input checked="" type="checkbox"/>
Masking Fault Detection >	<b>Rated output voltage(V)</b> 220V
Other Setting >	<b>Off-grid start-up battery capacity(%)</b> 0
Hybrid Setting >	<b>Support Normal Load</b> <input checked="" type="checkbox"/>
Logout	<b>Force Charge Start Capacity of charger Start(SOC %)</b> 10
Quick Set... Chart Home Log Console	<b>Force Charge End Capacity of charger End(SOC %)</b> 15

## GEN Port setting

### • Smart Load Output Mode Introduction

1. Go to [Hybrid Setting > GEN Port](#) page and choose [Smart Load Output](#) as below.

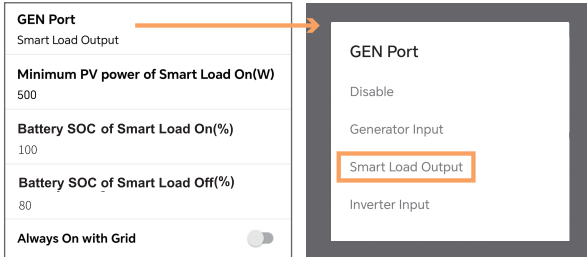

**Smart Load Output Mode:** Under this mode, the GEN Port works as an output port for the Smart Load connected to the GEN terminal.

2. All parameters have been set by default.

**Minimum PV power of Smart Load On(W):** Minimum PV input power above which the Smart Load will switch on. Also, the battery SOC should exceed the setting value (%) simultaneously and then the Smart Load will switch on.

**Battery SOC of Smart Load On (%):** Battery SOC above which the Smart Load will switch on. Also, the PV input power should exceed the setting value (Power) simultaneously and then the Smart Load will switch on.

**Battery SOC of Smart Load Off (%):** Battery SOC below which the Smart Load will switch off.

**Always On with Grid:** When click “Always On with Grid” the Smart Load will switch on when the grid is present.

The default values of [Smart Load Output](#) are as below:

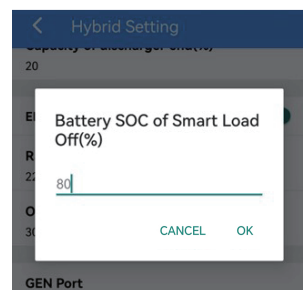
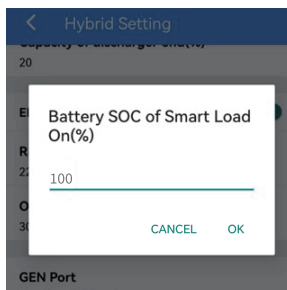
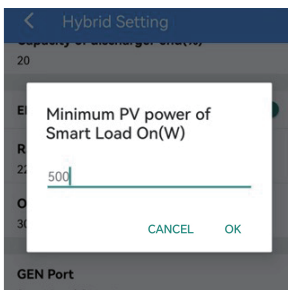

3. If the values are set as described above, the situations are as follows:

When [Always On with Grid](#) is ON, if the grid is present, the Smart Load will be ON all the time. It is not affected by the change of above parameters. If the grid is not present, the Smart Load will be OFF.

When [Always On with Grid](#) is OFF, if the PV power  $\geq 500$ W and the Battery SOC  $\geq 100\%$ , the GEN Port function will be enabled and the Smart Load will be ON. If the PV power  $< 500$ W or the Battery SOC  $< 80\%$ , the GEN Port function will be disabled and the Smart Load will be OFF.



### • Generator Input Mode Introduction

1. Go to [Hybrid Setting > GEN Port](#) page and choose [Generator Input](#) as below.

Note: You need to shut down the Inverter to set the Generator Input Mode.

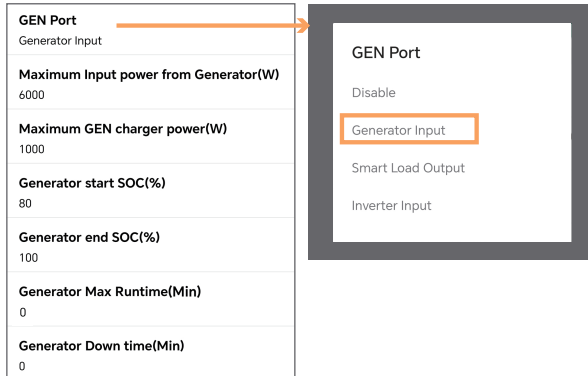

**Generator Input Mode:** Under this mode, the GEN Port works as an input port from the generator while under Off-Grid condition. The Generator Input can charge the battery or take the backup load.

2. All parameters have been set by default.

**Maximum Input power from Generator (W):** Maximum input power from generator. Forbid the generator power larger than the setting value (W).

**Maximum GEN charger power (W):** Maximum battery charge power from generator.

**Generator start SOC (%):** Battery SOC below which the generator starts to charge the battery. Meanwhile, the generator running time should not exceed the maximum runtime setting value (Hour).

**Generator end SOC (%):** Battery SOC above which the generator stops charging the battery.

**Generator Max Runtime (Min):** The generator maximum running time in minutes. When the generator running time is larger than the setting value, the Gen Port will cut off. When the runtime be set to 0 minutes, means the generator will run all the time.

**Generator Down time (Min):** The Generator Down time in minutes after inverter stop working. (Max. Generator Down time: 10 mins)

Note: The total generator running time equal to “Generator Max Runtime (Hour)” plus “Generator Down time (Min)”.

The default values of **Generator Input** are as below:

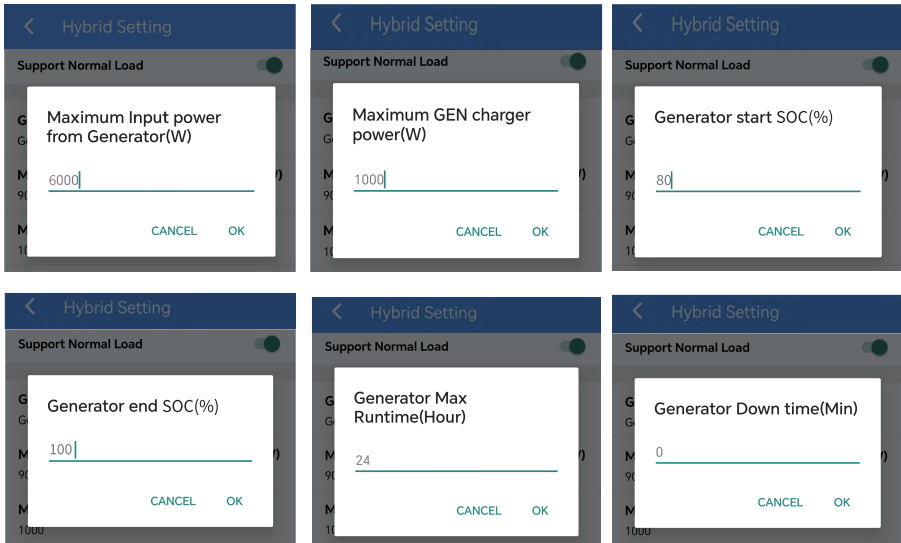

3. If the values are set as described above, the situations are as follows:

Under Off-Grid mode, when the Battery SOC  $\leq 80\%$  and the Runtime  $\leq$  Generator Max Runtime (Hour), the GEN Port function will be enabled and the Generator Input will be ON. When the Battery SOC  $\geq 100\%$  or the Runtime is over Generator Max Runtime (Hour), the GEN Port function will be disabled and the Generator Input will be OFF.

Under On-Grid mode, the GEN Port function will be disabled and the Generator Input will be OFF.

Note:

1. If Generator and Grid are normal, preferably powered by Grid power.
2. Generator Max Runtime (Hour) = 24, means generator can run all the time.

### • Inverter Input Mode Introduction

1. Go to [Hybrid Setting > GEN Port](#) page and choose [Inverter Input](#).

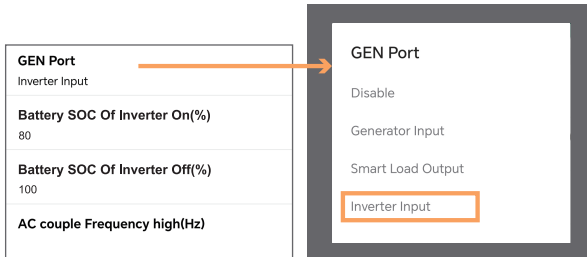

**Inverter Input Mode:** Under this mode, the GEN Port works as an input port from other grid-tied inverter whose rated power should be less than the hybrid inverter. The grid-tied inverter should also support derating output power according to the output frequency.

2. All parameters have been set by default.

**Battery SOC Of Inverter On (V):** Battery SOC below which the Inverter powers on and starts charging the battery.

**Battery SOC Of Inverter Off (V):** Battery SOC above which the Inverter powers off and stops charging the battery.

**AC couple Frequency high (Hz):** This parameter is used to limit the output power of grid-tied inverter when the hybrid inverter works under off-grid mode. The highest output frequency of the hybrid inverter is limited by this setting value.

The default values of [Inverter Input](#) are as below:

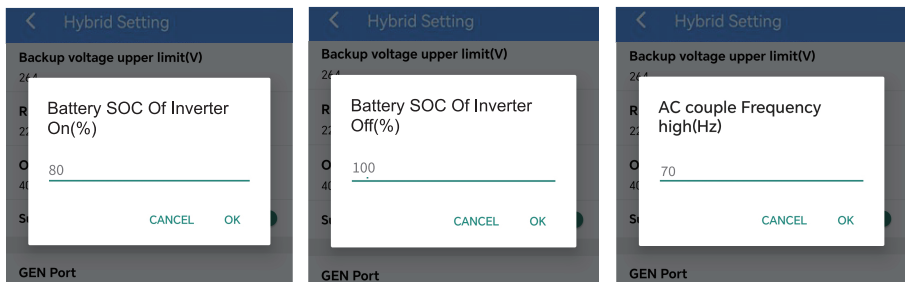

3. If the values are set as described above, the situations are as follows:

Under off-grid mode, when the Battery SOC  $\leq 80\%$ , the GEN port function will be enabled and Inverter Input will be ON. When the Battery SOC  $\geq 100\%$ , the GEN port function will be disabled and Inverter Input will be OFF. When the battery charge power lower than the grid-tied inverter output power, the hybrid inverter will increase the output frequency to maximum 70Hz. Then the grid-tied inverter will work in limited power mode.

Under on-grid mode, the grid-tied inverter works as normal regardless of battery capacity.

### Logic Diagram of Enable/Disable GEN Port Function

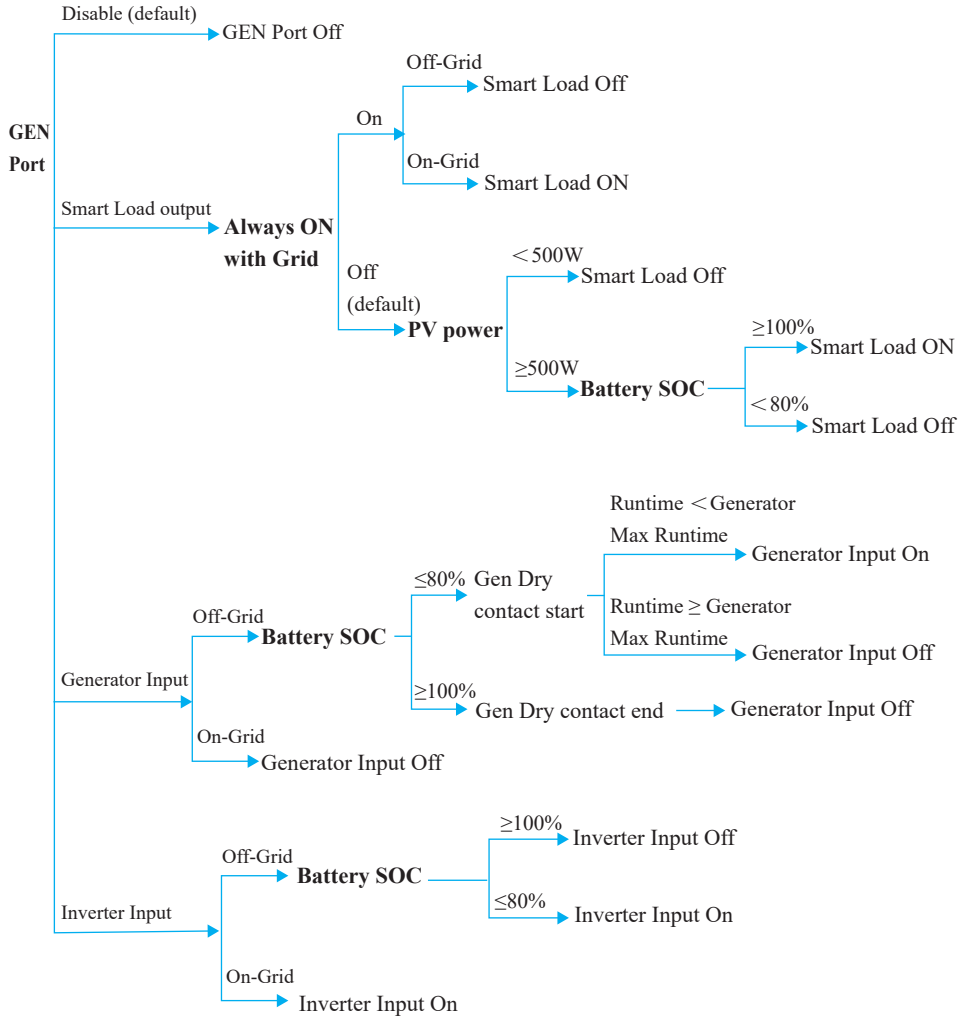

## 8. Maintenance

 <b>CAUTION</b>	<p>Before maintaining and commissioning inverter and its peripheral distribution unit, switch off all the charged terminals of the inverter and wait at least 10 minutes after the inverter is powered off.</p>
--	---

### 8.1 Routine Maintenance

Items	Check Content	Maintain Content	Maintenance Interval
Inverter output status	Statistically maintain the status of electrical yield, and remotely monitor its abnormal status.	N/A	Weekly
Inverter cleaning	Check periodically that the heat sink is free from dust and blockage.	Clean periodically the heat sink.	Yearly
Inverter running status	Check that the inverter is not damaged or deformed. Check for normal sound emitted during inverter operation. Check and ensure that all inverter communications are running well.	If there is any abnormal phenomenon, replace the relevant parts.	Monthly
Inverter electrical connections	Check that all AC, DC and communication cables are securely connected; Check that PGND cables are securely connected; Check that all cables are intact and free from aging.	If there is any abnormal phenomenon, replace the cable or re-connect it.	Semiannually

## 8.2 Inverter Troubleshooting

When the inverter has an exception, its basic common warning and handling methods are shown below.

Code	Alarm Information	Suggestions
A0	Grid over voltage	<ol style="list-style-type: none"> <li>1. If the alarm occurs occasionally, possibly the power grid voltage is abnormal temporarily, and no action is required.</li> <li>2. If the alarm occurs repeatedly, contact the local power station. After receiving approval of the local power bureau, revise the electrical protection parameter settings on the inverter through the App.</li> <li>3. If the alarm persists for a long time, check whether the AC circuit breaker /AC terminals is disconnected, or if the grid has a power outage.</li> </ol>
A1	Grid under voltage	
A3	Grid over frequency	
A4	Grid under frequency	
A2	Grid absent	Wait till power is restored.
B0	PV over voltage	Check whether the maximum input voltage of a single PV string exceeds the MPPT working voltage. If yes, modify the number of PV module connection strings.
B1	PV insulation abnormal	<ol style="list-style-type: none"> <li>1. Check the insulation resistance against the ground for the PV strings. If a short circuit has occurred, rectify the fault.</li> <li>2. If the insulation resistance against the ground is less than the default value in a rainy environment, set insulation resistance protection on the App.</li> </ol>
B2	Leakage current abnormal	<ol style="list-style-type: none"> <li>1. If the alarm occurs occasionally, the inverter can be automatically recovered to the normal operating status after the fault is rectified.</li> <li>2. If the alarm occurs repeatedly, contact your dealer for technical support.</li> </ol>
B4	PV under voltage	<ol style="list-style-type: none"> <li>1. If the alarm occurs occasionally, possibly the external circuits are abnormal accidentally. The inverter automatically recovers to the normal operating status after the fault is rectified.</li> <li>2. If the alarm occurs repeatedly or last a long time, check whether the insulation resistance against the ground of PV strings is too low.</li> </ol>
C0	Internal power supply abnormal	<ol style="list-style-type: none"> <li>1. If the alarm occurs occasionally, the inverter can be automatically restored, and no action is required.</li> <li>2. If the alarm occurs repeatedly, please contact the customer service.</li> </ol>

C2	Inverter over dc-bias current	<ol style="list-style-type: none"> <li>1. If the alarm occurs occasionally, possibly the power grid voltage is abnormal temporarily, and no action is required.</li> <li>2. If the alarm occurs repeatedly, and the inverter fails to generate power, contact the customer service.</li> </ol>
C3	Inverter relay abnormal	<ol style="list-style-type: none"> <li>1. If the alarm occurs occasionally, possibly the power grid voltage is abnormal temporarily, and no action is required.</li> <li>2. If the alarm occurs repeatedly, pls. refer to the suggestions or measures of Grid over voltage. If the inverter fails to generate power, contact the customer service center. If there is no abnormality on the grid side, the machine fault can be determined. (If you open the cover and find traces of damage to the relay, it can be concluded that the machine is faulty.) And pls. contact the customer service.</li> </ol>
CN	Remote off	<ol style="list-style-type: none"> <li>1. Local manual shutdown is performed in APP.</li> <li>2. The monitor executed the remote shutdown instruction.</li> <li>3. Remove the communication module and confirm whether the alarm disappears. If yes, replace the communication module. Otherwise, please contact the customer service.</li> </ol>
C5	Inverter over temperature	<ol style="list-style-type: none"> <li>1. If the alarm occurs occasionally, the inverter can be automatically recovered. No action is required.</li> <li>2. If the alarm occurs repeatedly, please check whether the installation site has direct sunlight, bad ventilation, or high ambient temperature (such as installed on the parapet). Yet, if the ambient temperature is lower than 45° C and the heat dissipation and ventilation is good, please contact customer service.</li> </ol>
C6	GFCI abnormal	<ol style="list-style-type: none"> <li>1. If the alarm occurs occasionally, it could have been an occasional exception to the external wiring. The inverter can be automatically recovered. No action is required.</li> <li>2. If it occurs repeatedly or cannot be recovered for a long time, please contact customer service.</li> </ol>
B7	PV string reverse	Check and modify the positive and negative polarity of the input string.
C8	Fan abnormal	<ol style="list-style-type: none"> <li>1. If the alarm occurs occasionally, please restart the inverter.</li> <li>2. If it occurs repeatedly or cannot be recovered for a long time, check whether the external fan is blocked by other objects. Otherwise, Please contact customer service.</li> </ol>
C9	Unbalance Dc-link voltage	<ol style="list-style-type: none"> <li>1. If the alarm occurs occasionally, the inverter can be automatically recovered. No action is required.</li> </ol>
CA	Dc-link over voltage	<ol style="list-style-type: none"> <li>2. If the alarm occurs repeatedly, the inverter cannot work properly. Please contact customer service.</li> </ol>

CB	Internal communication error	<ol style="list-style-type: none"> <li>1. If the alarm occurs occasionally, the inverter can be automatically recovered and no action is required.</li> <li>2. If the alarm occurs repeatedly, the inverter cannot work properly. Pls. contact the customer service center.</li> </ol>
CC	Software incompatibility	<ol style="list-style-type: none"> <li>1. If the alarm occurs occasionally, the inverter can be automatically recovered and no action is required.</li> <li>2. If the alarm occurs repeatedly, the inverter cannot work properly. Pls. contact the customer service center.</li> </ol>
CD	Internal storage error	<ol style="list-style-type: none"> <li>1. If the alarm occurs occasionally, the inverter can be automatically recovered and no action is required.</li> <li>2. If the alarm occurs repeatedly, the inverter cannot work properly. Pls. contact the customer service center.</li> </ol>
CE	Data inconsistency	<ol style="list-style-type: none"> <li>1. If the alarm occurs occasionally, the inverter can be automatically recovered and no action is required.</li> <li>2. If the alarm occurs repeatedly, the inverter cannot work properly. Pls. contact the customer service center.</li> </ol>
CF	Inverter abnormal	<ol style="list-style-type: none"> <li>1. If the alarm occurs occasionally, the inverter can be automatically recovered and no action is required.</li> <li>2. If the alarm occurs repeatedly, the inverter cannot work properly. Pls. contact the customer service center.</li> </ol>
CG	Boost abnormal	<ol style="list-style-type: none"> <li>1. If the alarm occurs occasionally, the inverter can be automatically recovered and no action is required.</li> <li>2. If the alarm occurs repeatedly, the inverter cannot work properly. Pls. contact the customer service center.</li> </ol>
CJ	Meter lost	<ol style="list-style-type: none"> <li>1. Check the meter parameter Settings</li> <li>2. Local APP checks that the communication address of the inverter is consistent with that of the electricity meter</li> <li>3. The communication line is connected incorrectly or in bad contact</li> <li>4. electricity meter failure.</li> <li>5. Exclude the above, if the alarm continues to occur, please contact the customer service center.</li> </ol>



D2	Battery over voltage	<ol style="list-style-type: none"> <li>1. If the alarm occurs occasionally, the inverter can be automatically recovered and no action is required.</li> <li>2. Check whether the battery overvoltage protection value is improperly set.</li> <li>3. The battery is abnormal.</li> <li>4. If exclude the above, the alarm continues to occur, please contact customer service.</li> </ol>
D3	Battery under voltage	<ol style="list-style-type: none"> <li>1. If the alarm occurs occasionally, the inverter can be automatically recovered and no action is required.</li> <li>2. Check the communication line connection between BMS and inverter (lithium battery).</li> <li>3. The battery is empty or the battery voltage is lower than the SOC cut-off voltage.</li> <li>4. The battery undervoltage protection value is improperly set.</li> <li>5. The battery is abnormal.</li> <li>6. If exclude the above, the alarm continues to occur, please contact the customer service center.</li> </ol>
D4	Battery discharger over current	<ol style="list-style-type: none"> <li>1. Check whether the battery parameters are correctly set.</li> <li>2. The battery is undervoltage.</li> <li>3. Check whether a separate battery is loaded and the discharge current exceeds the battery specifications.</li> <li>4. The battery is abnormal.</li> <li>5. If exclude the above, and the alarm continues to occur, please contact customer service.</li> </ol>
D5	Battery over temperature	<ol style="list-style-type: none"> <li>1. If the alarm occurs repeatedly, please check whether the installation site is in direct sunlight and whether the ambient temperature is too high (such as in a closed room).</li> </ol>
D6	Battery under temperature	<ol style="list-style-type: none"> <li>2. If the battery is abnormal, replace it with a new one.</li> <li>3. If exclude the above, and the alarm continues to occur, please contact the customer service center.</li> </ol>
D7	BACKUP output voltage abnormal	<ol style="list-style-type: none"> <li>1. Check whether the BACKUP voltage and frequency Settings are within the specified range.</li> <li>2. Check whether the BACKUP port is overloaded.</li> <li>3. When not connected to the power grid, check whether BACKUP output is normal.</li> <li>4. If exclude the above, and the alarm continues to occur, please contact customer service.</li> </ol>
D8	Communication error (Inverter-BMS)	<ol style="list-style-type: none"> <li>1. Check whether the battery is disconnected.</li> <li>2. Check whether the battery is well connected with the inverter.</li> <li>3. Confirm that the battery is compatible with the inverter. It is recommended to use CAN communication.</li> <li>4. Check whether the communication cable or port between the battery and the inverter is faulty.</li> <li>5. If exclude the above, and the alarm continues to occur, please contact the customer service center.</li> </ol>

D9	Internal communication loss (E-M)	1. Check whether the communication cables between EPS, electricity meter and inverter are well connected and whether the wiring is correct 2. Check whether the communication distance is within the specified range 3. Disconnect the external communication and restart the electricity meter and inverter.
DA	Internal communication loss (M-D)	4. If exclude the above, and the alarm continues to occur, please contact the customer service center.
CU	Dcdc abnormal	1. If the alarm occurs occasionally, the inverter can be automatically recovered and no action is required. 2. If the alarm occurs repeatedly, please check: 1) Check whether the MC4 terminal on the PV side is securely connected. 2) Check whether the voltage at the PV side is open circuit, short circuit or ground to ground, etc. If exclude the above, and the alarm continues to occur, please contact the customer service center.
CP	BACKUP over dc-bias voltage	1. If the alarm occurs occasionally, the inverter can be automatically recovered and no action is required. 2. If the alarm occurs repeatedly, the inverter cannot work properly. Pls. contact the customer service center.
DB	BACKUP short circuit	1. Check whether the live line and null line of BACKUP output are short-circuited. 2. If it is confirmed that the output is not short-circuited or an alarm, please contact customer service to report for repair (after the troubleshooting of alarm problems, BACKUP switch needs to be manually turned on during normal use).
DC	BACKUP over load	1. Disconnect the BACKUP load and check whether the alarm is lifted 2. If the load is disconnected but the alarm still exists, please contact the customer service. (After the alarm is lifted, the BACKUP switch needs to be manually turned on for normal use.)

## 9. Technical Specification

Model	8K EU	10K EU
<b>Input (PV)</b>		
Max. Input Power	12000W	15000W
MPPT Range(Full load)	200V~480V	200V~480V
MPPT Range	70V-540V	
Max. DC Voltage	600V	
Max. Input Current	30A/22A/22A	
Max. Short Current	40A/30A/30A	
MPP Tracker No.	3	
<b>Input (Battery)</b>		
Compatible battery type	Lithium-ion/Lead-acid	
Nominal battery voltage(Full load)	48V	
Battery voltage range	40V-64V	
Max. charge/discharge current	210A/180A	210A/210A
Max. charge/discharge power	10000W/8000W	10000W/10000W
Lithium battery charge curve	Self-adaption to BMS	
<b>Output (On Grid)</b>		
AC Input Max.Power	12000W	15000W
AC Output Rated Power	8000W	10000W
AC Output Maximum Power	8800W	11000W
C Output Maximum Apparent Power	8800W	11000W
Nominal Voltage	230V(Single phase)	
Maximum Current(Output)	40A	50A
Maximum Current(Input)	52.5A	65.3A
Power Factor Range	-0.8(lagging)~0.8(leading)	
Rated Frequency	50/60 Hz	
<b>Output (BackUp)</b>		
Nom. Power	8000VA	10000VA
Maximum Power (60s)	12000VA	15000VA
Apparent Power (10s)	16000VA	20000VA
Nominal Voltage	230V(Single phase)	
THD	3%(R) , 5%(RCD)	
Parallel	9Pcs	
<b>Efficiency</b>		
Max. Efficiency(PV to Grid)	97.8%	97.8%
CEC. Efficiency(PV to Grid)	97.2%	97.2%
Max.Charge Efficiency(PV to Battery)	95%	95%
Max.Charge/Discharge Efficiency (Grid to Battery)	95%	95%

General	
Temp. Range	-25~60 °C
Max. operation altitude	4000m
Topology	Transformerless (PV to Grid)/Transformer (Bat to Grid)
Protection	IP65/Type 4X
Noise emission	45dB
Humidity	0~100%, non-condensing
Cooling	Smart Cooling
HMI & COM	
Display	LED+APP(Bluetooth), LCD(optional)
Communication interface	BMS(CAN/RS485)
	RS485(optional)/WiFi/GPRS/4G/Ethernet(optional)
	DI
	Meter(RS485)
	I*DO
Protection	
Anti-islanding protection	YES
AC over-current protection	YES
AC short-circuit protection	YES
AC over-voltage protection	YES
SPD	DC Type2 , AC Type2
Insulation detection	YES
GFCI	YES
AFCI	NA
RSD	NA
GEN	YES
Mechanical	
W x H x D	420*800*240mm
Weight	37kg
DC switch	Internal
AC Connection	NA
PV Connection	NA
Battery Connection	NA
Compliance	
Grid	NRS 0-97/ IEC61727/IEC62116
Safety	IEC62109
Overvoltage Cat.	DC: OVC II / AC: OVC III
EMC Emission	EN 61000-6-3
EMI EMC Immunity	EN 61000-6-1

Remarks :

- \*Not yet test ;
- \*\*The range of output voltage and frequency may vary depending upon different grid codes.
- Specifications are subject to change without advance notice.